

SHARP[®]

MODEL: MX-2300G MX-3500N
MX-2300N MX-3501N
MX-2700G MX-4500N
MX-2700N MX-4501N

Printer Guide



CONTENTS

ABOUT THIS MANUAL	3
• MANUALS PROVIDED WITH THE MACHINE ...	4
PRINTER FUNCTION OF THE MACHINE.....	5

1 PRINTING FROM WINDOWS

BASIC PRINTING PROCEDURE.....	6
• SELECTING THE PAPER	8
PRINTING WHEN THE USER AUTHENTICATION FUNCTION IS ENABLED.....	9
VIEWING PRINTER DRIVER HELP.....	11
SELECTING THE COLOUR MODE.....	12
TWO-SIDED PRINTING	14
FITTING THE PRINT IMAGE TO THE PAPER	16
PRINTING MULTIPLE PAGES ON ONE PAGE	18
STAPLING OUTPUT/PUNCHING HOLES IN OUTPUT	20

2 CONVENIENT PRINTING FUNCTIONS IN WINDOWS

CONVENIENT FUNCTIONS FOR CREATING PAMPHLETS AND POSTERS.....	22
• CREATING A PAMPHLET (Pamphlet/Pamphlet Staple).....	22
• INCREASING THE MARGIN (Margin Shift).....	23
• CREATING A LARGE POSTER (Poster Printing)	23
FUNCTIONS TO ADJUST THE SIZE AND ORIENTATION OF DATA	24
• ROTATING THE PRINT IMAGE 180 DEGREES (Rotate 180 degrees).....	24
• ENLARGEMENT/REDUCTION (Zoom/XY-Zoom)	24
• REVERSING THE IMAGE (Mirror Image)	25
COLOUR MODE ADJUSTMENT FUNCTION	26
• ADJUSTING THE BRIGHTNESS AND CONTRAST OF THE IMAGE (Color Adjustment)	26
• PRINTING LIGHT COLOUR CHARACTERS OR LINES IN BLACK (Text To Black/Vector To Black)	26
• SELECTING COLOUR SETTINGS TO MATCH THE IMAGE TYPE (Image Type).....	27

FUNCTIONS THAT COMBINE TEXT AND IMAGES	28
• ADDING A WATERMARK TO PRINTED PAGES (Watermark)	28
• PRINTING AN IMAGE OVER THE PRINT DATA (Image Stamp)	29
• CREATING OVERLAYS FOR PRINT DATA (Overlays).....	30
PRINT FUNCTIONS FOR SPECIAL PURPOSES ...	31
• PRINTING SPECIFIED PAGES ON DIFFERENT PAPER (Different Paper).....	31
• ADDING INSERTS WHEN PRINTING ON TRANSPARENCY FILM (Transparency Inserts)	32
• PRINTING A CARBON COPY (Carbon Copy)...	33
• PRINTING TEXT ON TABS OF TAB PAPER (Tab Printing)	34
CONVENIENT PRINTER FUNCTIONS	35
• USING TWO MACHINES TO PRINT A LARGE PRINT JOB (Tandem Print)	35
• USING THE DOCUMENT FILING FUNCTION (Retention/Document Filing).....	36
SAVING FREQUENTLY USED PRINT SETTINGS ..	37
• SAVING SETTINGS AT THE TIME OF PRINTING	37
• USING SAVED SETTINGS	39
CHANGING THE PRINTER DRIVER DEFAULT SETTINGS	40

3 PRINTING FROM A MACINTOSH

BASIC PRINTING PROCEDURE.....	42
• SELECT PAPER SETTINGS	42
• PRINT	43
• SELECTING THE PAPER	45
PRINTING WHEN THE USER AUTHENTICATION FUNCTION IS ENABLED.....	46

4 PRINTING WITHOUT THE PRINTER DRIVER

DIRECTLY PRINTING FROM THE MACHINE.	48
• DIRECTLY PRINTING A FILE ON AN FTP SERVER.	48
• DIRECTLY PRINTING A FILE IN USB MEMORY	50
DIRECTLY PRINTING FROM A COMPUTER	52
• SUBMIT PRINT JOB	52
• FTP PRINT	52
• E-MAIL PRINT	53
PRINTING AN ENCRYPTED PDF FILE.	54

5 CHANGING THE JOB QUEUE

GIVING A PRINT JOB PRIORITY / CANCELLING A PRINT JOB	55
• GIVING A PRINT JOB PRIORITY	55
• CANCELLING A PRINT JOB	56
CHANGING TO ANOTHER PAPER SIZE AND PRINTING WHEN PAPER RUNS OUT	57

6 PRINTER DRIVER SPECIFICATIONS

PRINTER DRIVER SPECIFICATION LIST	58
--	-----------

ABOUT THIS MANUAL

Please note

- For information on installing the drivers and software cited in this manual, please refer to the separate Software Setup Guide.
- For information on your operating system, please refer to your operating system manual or the online Help function.
- The explanations of screens and procedures in this manual are primarily for Windows® XP in Windows® environments, and Mac OS X v10.3.9 in Macintosh environments. The screens may vary depending on the version of the operating system.
- Wherever "MX-xxxx" appears in this manual, please substitute your model name for "xxxx".
- Where this manual shows the "MX-2300/2700 series" or the "MX-3500/4500 series", the following models are indicated:
MX-2300/2700 series: MX-2300G, MX-2300N, MX-2700G, MX-2700N
MX-3500/4500 series: MX-3500N, MX-3501N, MX-4500N, MX-4501N
- This manual contains references to the fax function. However, please note that the fax function is not available in some countries and regions.
- Considerable care has been taken in preparing this manual. If you have any comments or concerns about the manual, please contact your dealer or nearest authorised service representative.
- This product has undergone strict quality control and inspection procedures. In the unlikely event that a defect or other problem is discovered, please contact your dealer or nearest authorised service representative.
- Aside from instances provided for by law, SHARP is not responsible for failures occurring during the use of the product or its options, or failures due to incorrect operation of the product and its options, or other failures, or for any damage that occurs due to use of the product.

Warning

- Reproduction, adaptation or translation of the contents of the manual without prior written permission is prohibited, except as allowed under copyright laws.
- All information in this manual is subject to change without notice.

Illustrations and the operation panel and touch panel shown in this manual

The peripheral devices are generally optional, however, some models include certain peripheral devices as standard equipment. The explanations in this manual assume that a right tray and stand/2 x 500 sheet paper drawer are installed on the MX-2700N (equipped standard with an automatic document feeder).

To further explain certain functions and uses, some explanations assume that additional peripheral devices are installed.

<p>The display screens, messages, and key names shown in this manual may differ from those on the actual machine due to product improvements and modifications.</p>

MANUALS PROVIDED WITH THE MACHINE

Printed manuals and manuals stored in PDF format on the machine's hard drive are provided with the machine. When using the machine, read the appropriate manual for the feature you are using.

Printed manuals

Manual name	Contents
Safety Guide	This manual contains instructions for using the machine safely and lists the specifications of the machine and its peripheral devices.
Software Setup Guide	This manual explains how to install the software and configure settings to use the machine as a printer or scanner.
Quick Start Guide	This manual provides easy-to-understand explanations of all the functions of the machine in a single volume. Detailed explanations of each of the functions can be found in the manuals in PDF format.
Troubleshooting	This manual explains how to remove paper misfeeds and provides answers to frequently asked questions regarding the operation of the machine in each mode. Refer to this manual when you have difficulty using the machine.
Facsimile Quick Reference Guide	This manual explains the basic procedures for using the fax function of the machine, and provides an overview of the features of the fax function, troubleshooting procedures, and specifications. For detailed information on using the fax function and the system settings for fax, see the "Facsimile Guide" in PDF format.





Operation manuals in PDF format

The manuals in PDF format provide detailed explanations of the procedures for using the machine in each mode. To view the PDF manuals, download them from the hard drive in the machine. The procedure for downloading the manuals is explained in "How to download the manuals in PDF format" in the Quick Start Guide.

Manual name	Contents
User's Guide	This manual provides information, such as basic operation procedures, how to load paper, and machine maintenance.
Copier Guide	This manual provides detailed explanations of the procedures for using the copy function.
Printer Guide (This manual)	This manual provides detailed explanations of the procedures for using the printer function.
Facsimile Guide	This manual provides detailed explanations of the procedures for using the fax function and the "System Settings" that are related to fax.
Scanner Guide	This manual provides detailed explanations of the procedures for using the scanner function and the Internet fax function.
Document Filing Guide	This manual provides detailed explanations of the procedures for using the document filing function. The document filing function allows you to save the document data of a copy or fax job, or the data of a print job, as a file on the machine's hard drive. The file can be called up as needed.
System Settings Guide	This manual explains the "System Settings", which are used to configure a variety of parameters to suit the aims and the needs of your workplace. Current settings can be displayed or printed out from the "System Settings".

Icons used in the manuals

The icons in the manuals indicate the following types of information:

	This alerts you to a situation where there is a risk of machine damage or failure.		This indicates the name of a system setting and provides a brief explanation of the setting. For detailed information on each system setting, see the System Settings Guide. When "System Settings:" appears: A general setting is explained. When "System Settings (Administrator):" appears: A setting that can only be configured by an administrator is explained.
	This provides a supplemental explanation of a function or procedure.		
	This explains how to cancel or correct an operation.		

PRINTER FUNCTION OF THE MACHINE

This machine has a full colour printing function which can be used in a Windows environment as a standard feature. The printer driver can be installed from the provided CD-ROM to enable printing from your computer.

Expansion kits are available to enable the machine to be used in various environments.

For this reason, the following printer driver types are available for use with the machine. Please select a suitable printer driver depending on the expansion kits that are installed. The functions that are available vary depending on the printer driver type.

 [PRINTER DRIVER SPECIFICATION LIST](#) (page 58)

Printer driver type

PCL6, PCL5c: The machine supports the Hewlett-Packard PCL6 and PCL5c printer control languages. It is recommended that you use the PCL6 printer driver. If you have a problem printing from older software using the PCL6 printer driver, use the PCL5c printer driver.

SPLC-c: This is the SHARP proprietary printer driver. The printer driver compresses the data in each print job before sending the job to the machine, enabling smooth printing.
(SPLC is an acronym for "SHARP Printer Language with Compression".)

PS: This printer driver supports the PostScript 3 page description language developed by Adobe Systems Incorporated and enables the machine to be used as a PostScript 3 compatible printer.
(A PPD file is available if it is desired to use the Windows standard PS printer driver. To install the PPD file, see the Software Setup Guide.)

The printer drivers that can be used vary depending on your machine model. Check which printer drivers can be used in the tables below.

MX-2300G/2700G

Environment	Printer driver type	Requirements
Windows	SPLC-c*	Can be used in the standard machine configuration.
	PCL6, PCL5c	The printer expansion kit is required.
	PS	Macintosh

* Cannot be used when the printer expansion kit is installed.

MX-2300N/2700N or MX-3500/4500 series

Environment	Printer driver type	Requirements
Windows	PCL6, PCL5c	Can be used in the standard machine configuration.
	PS	Macintosh



The explanations in this manual of printing in a Windows environment generally use the PCL6 printer driver screens. The screens may vary slightly depending on the printer driver that you are using.

1

PRINTING FROM WINDOWS

BASIC PRINTING PROCEDURE

The following example explains how to print a document from "WordPad", which is a standard accessory program in Windows.

1

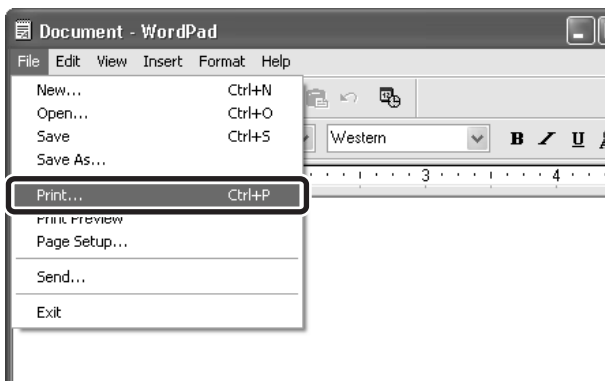

Select [Print] from the [File] menu of WordPad.



The menu used to execute printing may vary depending on the software application.

2

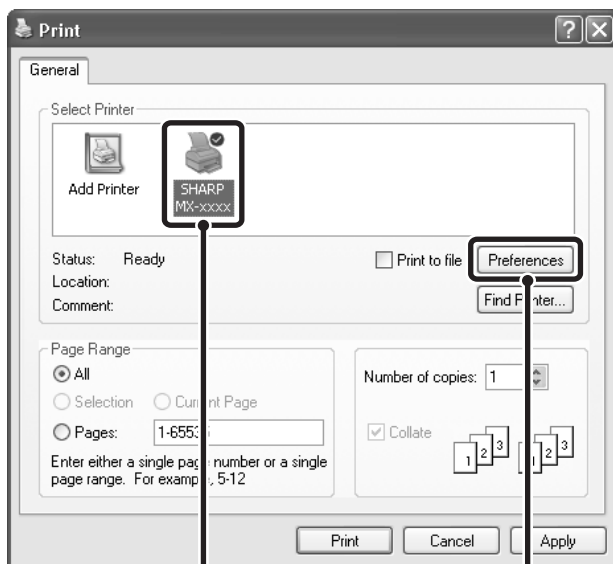

(1)

(2)

Open the printer driver properties window.

- (1) Select the printer driver of the machine.
 - If the printer drivers appear as icons, click the icon of the printer driver to be used.
 - If the printer drivers appear as a list, select the name of the printer driver to be used from the list.
- (2) Click the [Preferences] button.
 - In Windows 98/Me/NT 4.0, click the [Properties] button.
 - If you are using Windows 2000, the [Preferences] button does not appear. Click each tab in the "Print" dialog box to adjust the settings on that tab.



The button that is used to open the printer driver properties window (usually [Properties] or [Printing Preferences]) may vary depending on the software application.

3

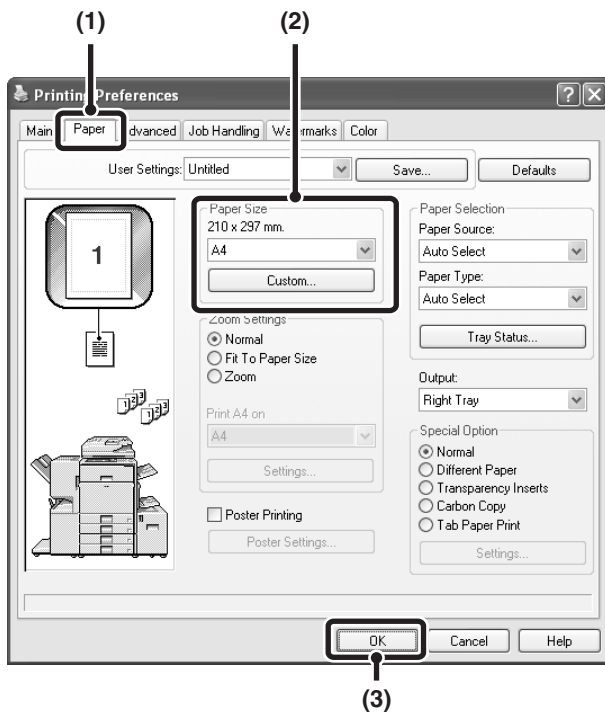

Select print settings.

(1) Click the [Paper] tab.

(2) Select the paper size.

To select settings on other tabs, click the desired tab and then select the settings.

(3) Click the [OK] button.

4

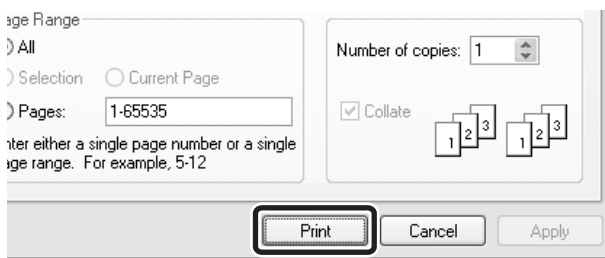

Click the [Print] button.

Printing begins.

In Windows 98/Me/NT 4.0, click the [OK] button.



The print job is delivered to the output tray, with the position of the paper offset slightly from the previous job (other than the right tray).

SELECTING THE PAPER

This section explains how to configure the "Paper Selection" setting on the [Paper] tab of the printer driver properties window.

Before printing, check the paper sizes, paper types, and paper remaining in the machine's trays. To view the most recent tray information, click the [Tray Status] button.

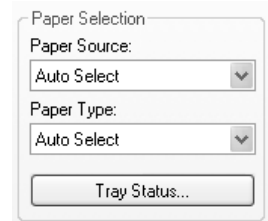

- **When [Auto Select] is selected in "Paper Source"**

The tray that has the size and type of paper selected in "Paper Size" and "Paper Type" on the [Paper] tab is automatically selected.

- **When other than [Auto Select] is selected in "Paper Source"**

The specified tray is used for printing regardless of the "Paper Size" setting.

- **When [Bypass Tray] is selected**

- Also select the "Paper Type". Check the bypass tray and make sure that the desired type of paper is loaded, and then select the appropriate "Paper Type" setting.



- Special media such as envelopes can also be placed in the bypass tray. For the procedure for loading paper and other media in the bypass tray, see "LOADING PAPER IN THE BYPASS TRAY" in the User's Guide.
- When "Enable Detected Paper Size in Bypass Tray" (disabled by factory default) or "Enable Selected Paper Type in Bypass Tray" (enabled by factory default) is enabled in the system settings (administrator), printing will not take place if the paper size or paper type specified in the printer driver is different from the paper size or paper type specified in the settings of the bypass tray.

- **When [Auto Select] is selected in "Paper Type"**

A tray with plain paper or recycled paper of the size specified in "Paper Size" is automatically selected. (The factory default setting is plain paper only.)

- **When other than [Auto Select] is selected in "Paper Type"**

A tray with the specified type of paper and the size specified in "Paper Size" is used for printing.



- **System Settings (Administrator): Exclude Bypass-Tray from Auto Paper Select**

- When [Auto Select] is selected in "Paper Selection", specify whether or not the paper in the bypass tray will be excluded from the paper that can be selected. This setting is disabled by factory default, and thus paper in the bypass tray is included in the paper that can be automatically selected. If special types of paper are frequently loaded in the bypass tray, it is recommended that this setting be enabled.

PRINTING WHEN THE USER AUTHENTICATION FUNCTION IS ENABLED

When the user authentication function is enabled in the machine's system settings (administrator), your user information (login name, password, etc.) must be entered in the setup screen of the printer driver before you can print. The information that must be entered varies depending on the authentication method being used, so check with the administrator of the machine before printing.

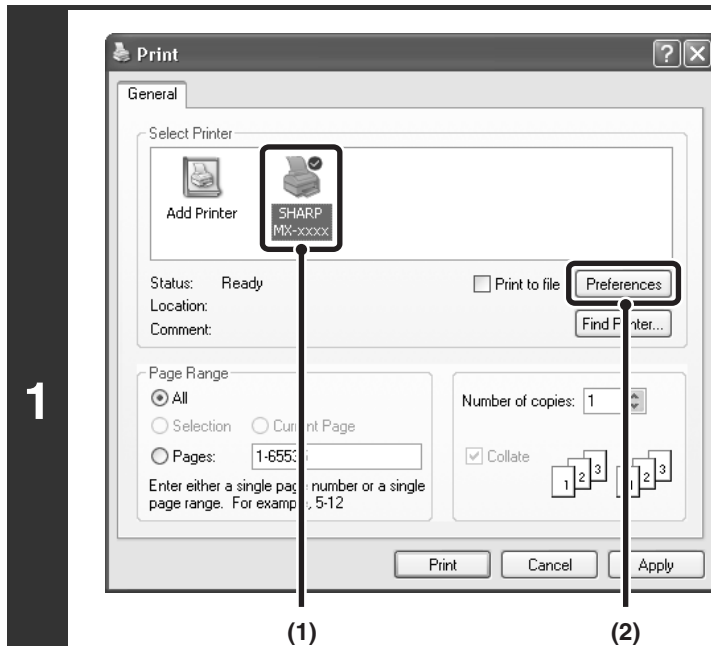

Open the printer driver properties window from the print window of the software application.

- (1) Select the printer driver of the machine.
- (2) Click the [Preferences] button.



The button that is used to open the printer driver properties window (usually [Properties] or [Printing Preferences]) may vary depending on the software application.

2

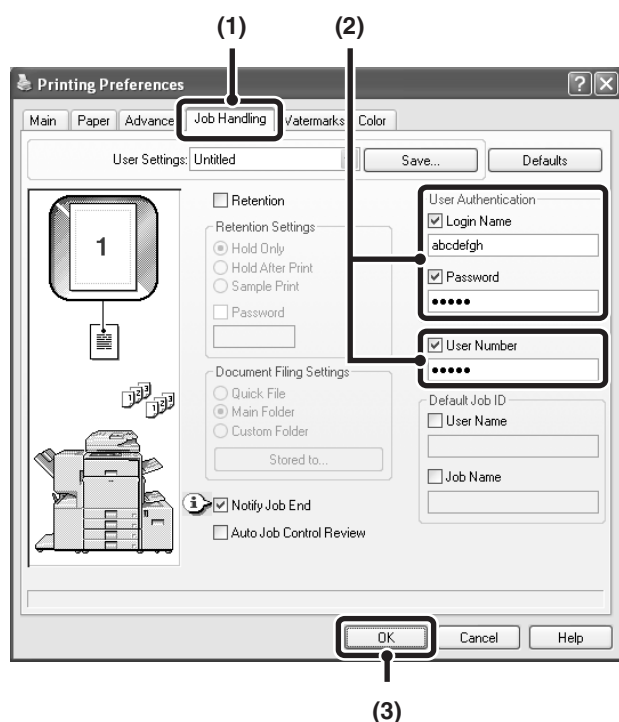

Enter your login name and password.

(1) Click the [Job Handling] tab.

(2) Enter your user information.

- When authentication is by login name/password
Select the [Login Name] and [Password] checkboxes so that checkmarks appear, and enter your login name and password. Enter 1 to 32 characters for the password.
- When authentication is by user number
Click the [User Number] checkbox and enter a user number (5 to 8 digits).

(3) Click the [OK] button.



To have a confirmation window appear before printing starts, select the [Auto Job Control Review] checkbox so that a checkmark appears.

3

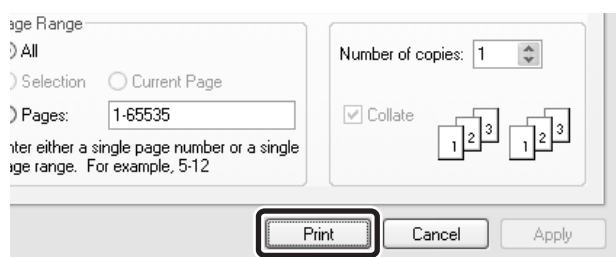

Start printing.



- Normally printing is possible without entering your user information. (In this case, the printed pages will be added to the "Others" count.) When printing by invalid users is prohibited in the system settings (administrator), printing is not permitted when user information is not entered or incorrect information is entered.
- The user authentication function of the machine cannot be used when the PPD file* is installed and the Windows standard PS printer driver is used. For this reason, printing will not be possible if printing by invalid users is prohibited in the system settings (administrator).
* The PPD file enables the machine to print using the standard PS printer driver of the operating system.



System Settings (Administrator): Disable Printing by Invalid User

This is used to prohibit printing of print jobs by users whose user information is not stored in the machine. When this function is enabled, printing is not allowed when user information is not entered or incorrect information is entered.

VIEWING PRINTER DRIVER HELP

When selecting settings in the printer driver, you can display Help to view explanations of the settings.

1

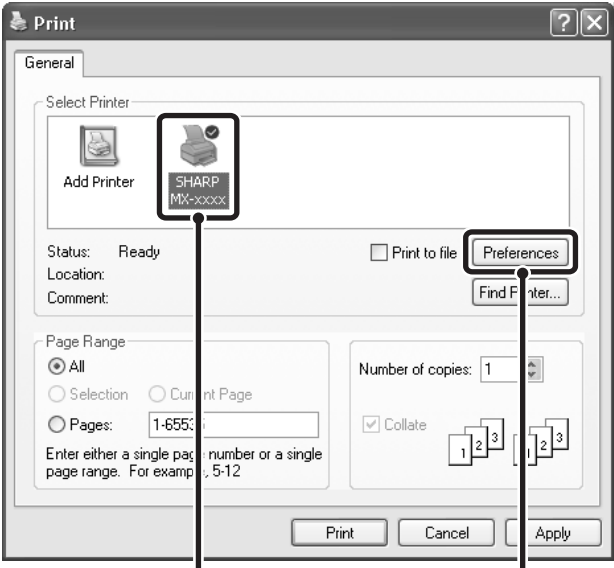

Open the printer driver properties window from the print window of the software application.

(1) Select the printer driver of the machine.
(2) Click the [Preferences] button.

 The button that is used to open the printer driver properties window (usually [Properties] or [Printing Preferences]) may vary depending on the software application.

2

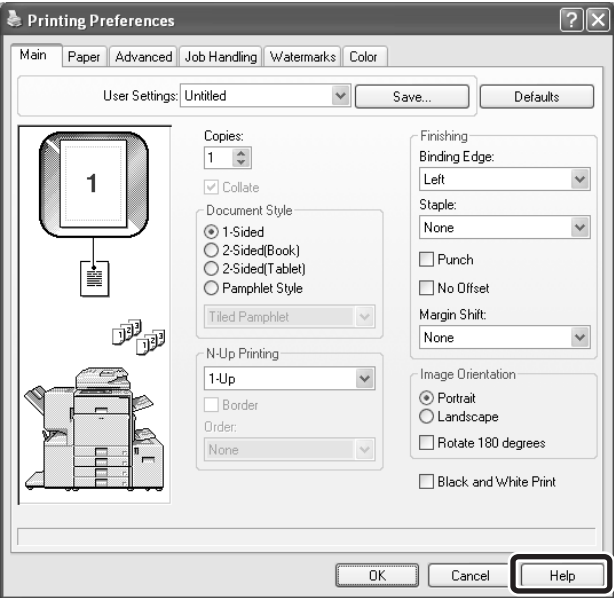

Click the [Help] button.

Pop-up help

To view Help for a setting, click the  button in the upper right-hand corner of the window and then click the setting. You can also view the same Help by right-clicking the setting and clicking the Help box that appears.

Information icon

Some restrictions exist on the combinations of settings that can be selected in the printer driver properties window. When a restriction exists on the selected setting, an information icon () will appear next to the setting. Click the icon to view an explanation of the restriction.

SELECTING THE COLOUR MODE

This section explains how to select the "Color Mode" on the [Color] tab of the printer driver properties window. The following three selections are available for the "Color Mode".

- Automatic:** The machine automatically determines whether each page is colour or black and white and prints the page accordingly. Pages with colours other than black and white are printed using Y (Yellow), M (Magenta), C (Cyan) and Bk (Black) toner. Pages that are only black and white are printed using Bk (Black) toner only. This is convenient when printing a document that has both colour and black and white pages, however, the printing speed is slower.
- Color:** All pages are printed in colour. Both colour data and black and white data are printed using Y (Yellow), M (Magenta), C (Cyan) and Bk (Black) toner.
- Black and White:** All pages are printed in black and white. Colour data such as images or materials for a presentation are printed using black toner only. This mode helps conserve colour toner when you do not need to print in colour, such as when proofreading or checking the layout of a document.



When [Automatic] is selected in the PCL6, PCL5c, or PS printer driver

Print data that includes images are counted as colour even though the data is black and white. To be always counted and printed as black and white, select [Black and White].

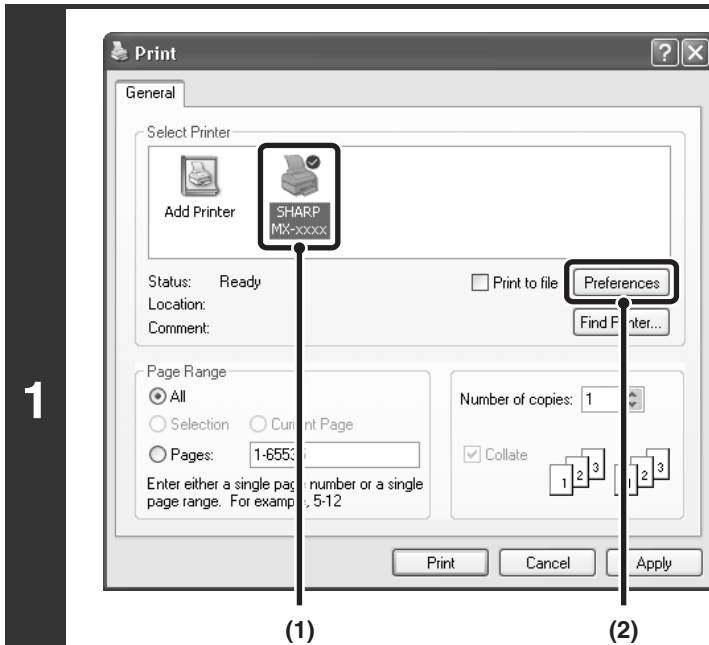

Open the printer driver properties window from the print window of the software application.

- (1) Select the printer driver of the machine.
- (2) Click the [Preferences] button.



The button that is used to open the printer driver properties window (usually [Properties] or [Printing Preferences]) may vary depending on the software application.

2

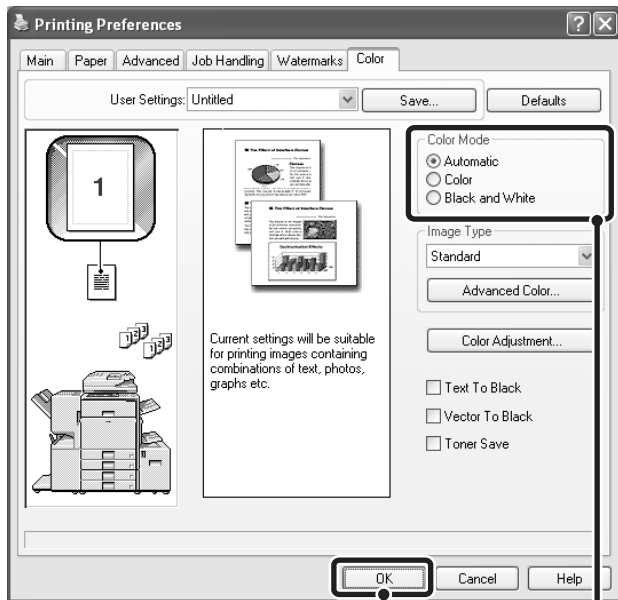

(2)

(1)

Select the colour mode.

(1) Select the "Color Mode" that you wish to use.

(2) Click the [OK] button.

3

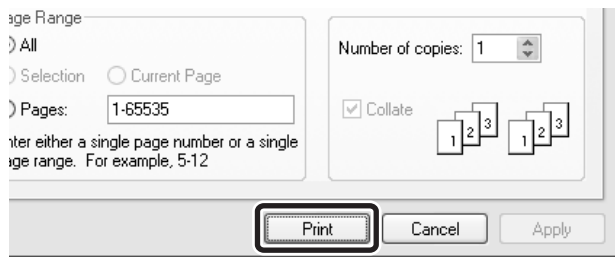

Start printing.

BLACK AND WHITE PRINTING

Black and white printing can be selected on the [Main] tab as well as on the [Color] tab. Click the [Black and White Print] checkbox on the [Main] tab so that a checkmark appears .

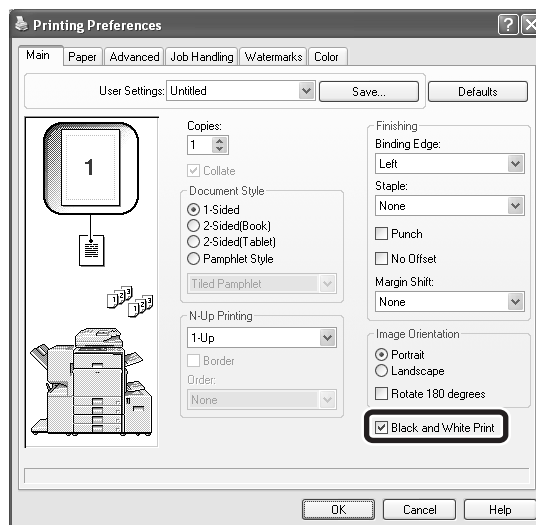

The [Black and White Print] checkbox on the [Main] tab and the "Color Mode" setting on the [Color] tab are linked together. When the [Black and White Print] checkbox is selected on the [Main] tab, [Black and White] is also selected on the [Color] tab.

TWO-SIDED PRINTING

The machine can print on both sides of the paper. This function is useful for many purposes, and is particularly convenient when you want to create a simple pamphlet. Two-sided printing also helps conserve paper.

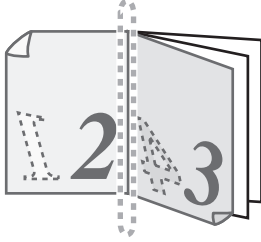
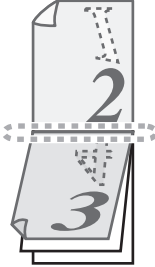
Printing result	
2-Sided (Book)	2-Sided (Tablet)
	
The pages are printed so that they can be bound at the side.	The pages are printed so that they can be bound at the top.

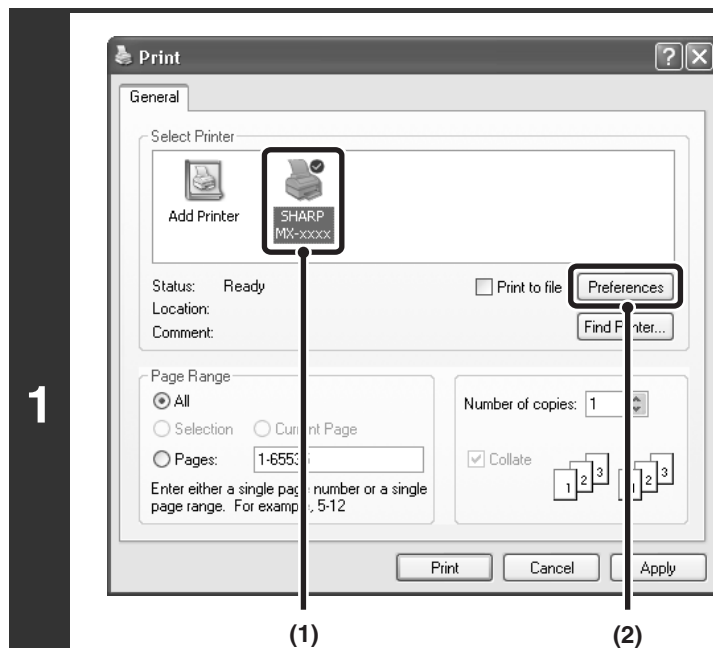

Open the printer driver properties window from the print window of the software application.

- (1) Select the printer driver of the machine.
- (2) Click the [Preferences] button.



The button that is used to open the printer driver properties window (usually [Properties] or [Printing Preferences]) may vary depending on the software application.

2

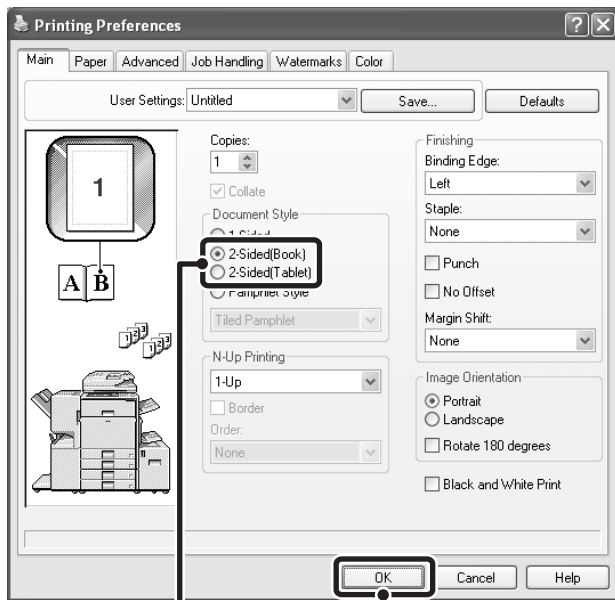

(1)

(2)

Select 2-sided printing.

(1) Select [2-Sided(Book)] or [2-Sided(Tablet)].

(2) Click the [OK] button.

3

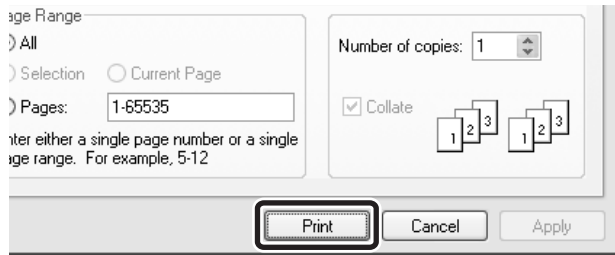

Start printing.

FITTING THE PRINT IMAGE TO THE PAPER

This function is used to automatically enlarge or reduce the printed image to the size of the paper loaded in the machine. This is convenient for such purposes as enlarging an A4 or letter size document to A3 or ledger size paper to make it easier to view, and to print when the same size of paper as the document image is not loaded in the machine.

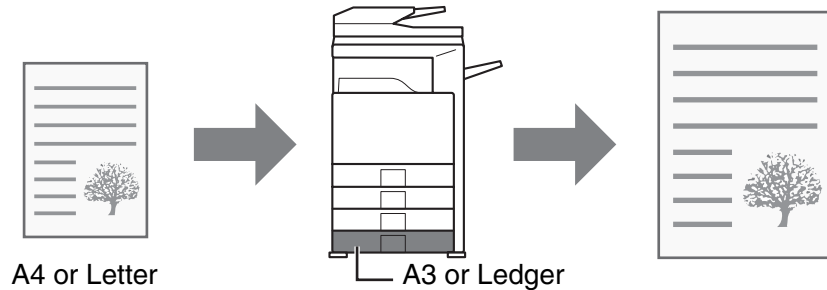

The explanation below assumes that you intend to print an A4 size document on A3 size paper.

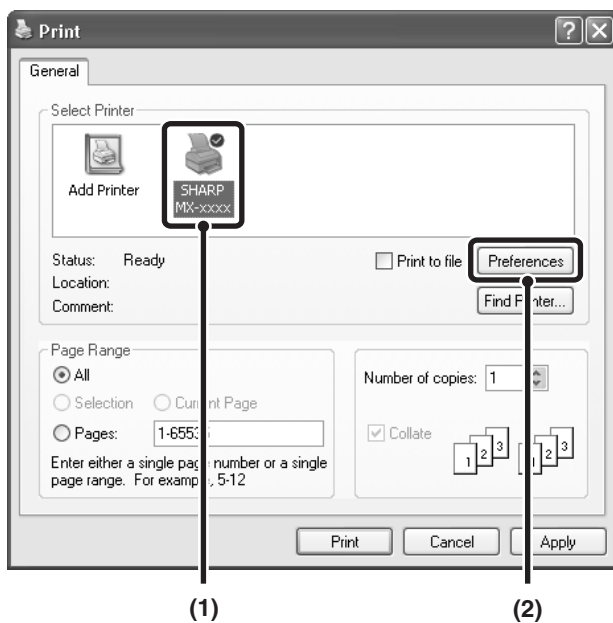

Open the printer driver properties window from the print window of the software application.

- (1) Select the printer driver of the machine.
- (2) Click the [Preferences] button.



The button that is used to open the printer driver properties window (usually [Properties] or [Printing Preferences]) may vary depending on the software application.

2

The screenshot shows the 'Printing Preferences' dialog box with the 'Paper' tab selected. Callout (1) points to the 'Paper' tab. Callout (2) points to the 'Paper Size' dropdown menu, which is set to 'A4'. Callout (3) points to the 'Fit To Paper Size' radio button in the 'Zoom Settings' section. Callout (4) points to the 'Print A4 on' dropdown menu, which is set to 'A3'. Callout (5) points to the 'OK' button at the bottom right of the dialog.

Select Fit to Page.

- (1) Click the [Paper] tab.
- (2) Select the paper size of the print image (for example: A4).
- (3) Select [Fit To Paper Size].
- (4) Select the actual paper size to be used for printing (for example: A3).
- (5) Click the [OK] button.

3

The screenshot shows the 'Page Range' dialog box. The 'Pages' field contains '1-65535'. The 'Number of copies' is set to '1'. The 'Collate' checkbox is checked. The 'Print' button is highlighted with a red box.

Start printing.





PRINTING MULTIPLE PAGES ON ONE PAGE

This function can be used to reduce a print image and print multiple pages on a single sheet of paper.

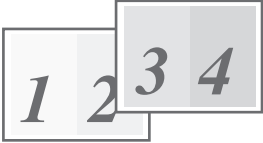
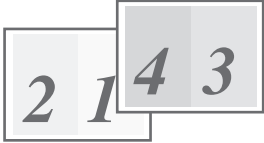
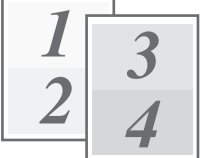
This is convenient when you want to print multiple images such as photos on a single sheet of paper, and when you want to conserve paper. This function can also be used in combination with 2-sided printing for maximum conservation of paper.

The print results of [2-Up] and [4-Up] are shown below for each selection in the "Order" menu.

N-Up	Print results		
	Left To Right	Right To Left	Top To Bottom (when the printing orientation is landscape)
[2-Up]			

N-Up	Right, and Down	Down, and Right	Left, and Down	Down, and Left
[4-Up]				



The order of 6-Up, 8-Up, 9-Up, and 16-Up is the same as 4-Up.

The order can be viewed in the print image in the printer driver properties window.

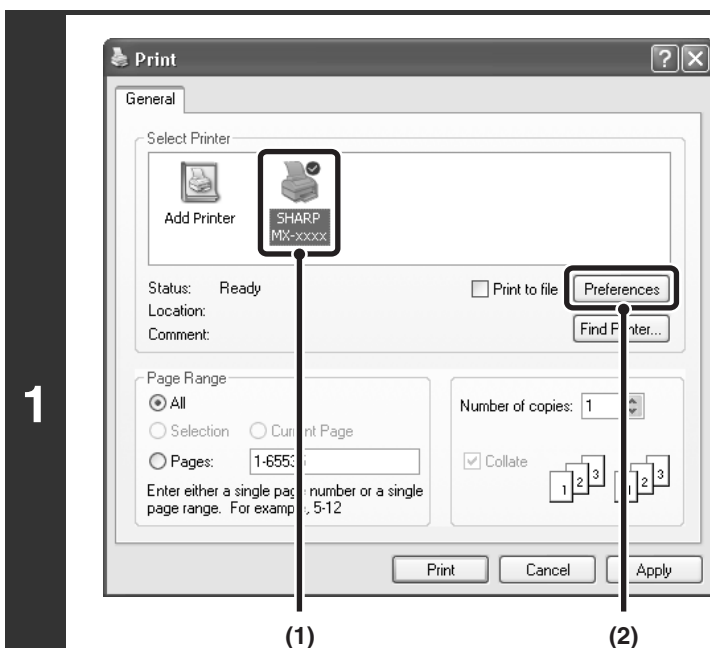

Open the printer driver properties window from the print window of the software application.

- (1) Select the printer driver of the machine.
- (2) Click the [Preferences] button.



The button that is used to open the printer driver properties window (usually [Properties] or [Printing Preferences]) may vary depending on the software application.

2

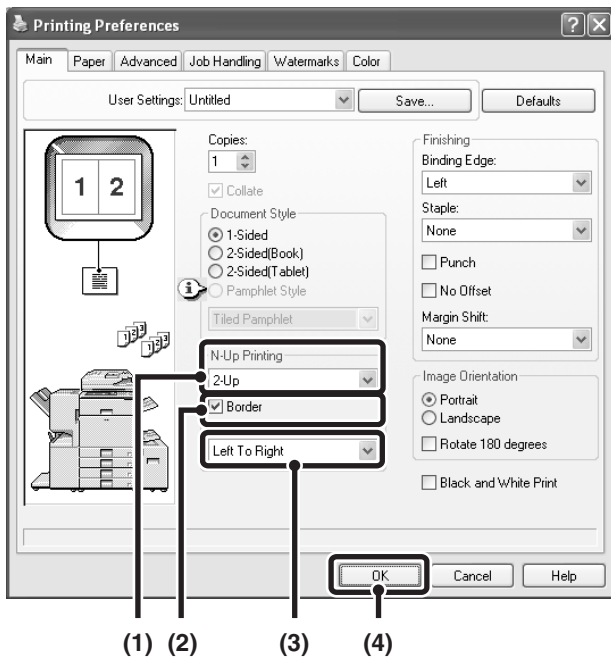

Select N-Up Printing.

- (1) Select the number of pages per sheet.
- (2) If you wish to print borderlines, click the [Border] checkbox so that a checkmark appears.
- (3) Select the order of the pages.
- (4) Click the [OK] button.

3

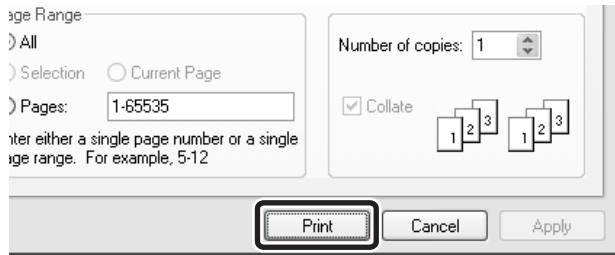



Start printing.

STAPLING OUTPUT/PUNCHING HOLES IN OUTPUT

Staple function

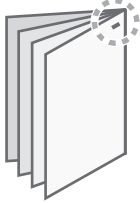
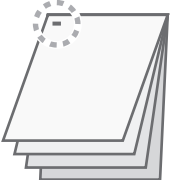

The staple function can be used to staple output.

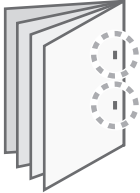
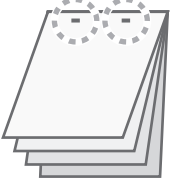
This function saves considerable time when preparing materials such as handouts for a meeting. The staple function can also be used in combination with 2-sided printing to create materials with a more sophisticated appearance. Stapling positions and the number of staples can be selected to obtain the following stapling results.

Staples	Left	Right	Top
[1 Staple]			
[2 Staples]			

Punch function

To punch holes in the output, click the [Punch] checkbox so that a checkmark appears. Punch hole positions can be set using [Binding Edge].

Left	Right	Top
		

- To use the staple function, a finisher or saddle stitch finisher is required.
- To use the punch function, a punch unit must be installed on the finisher or saddle stitch finisher.
- The number of holes that can be punched and the spacing between the holes varies depending on the installed punch module.
- The maximum number of sheets that can be stapled is as follows.
When a finisher is installed: 50 sheets (30 sheets for Foolscap, B4, or larger sizes)
When a saddle stitch finisher is installed: 30 sheets (25 sheets for Foolscap, B4, or larger sizes)
- The staple function and offset function cannot be used at the same time.
- When the finisher is disabled in the machine's system settings (administrator), the staple function and punch function cannot be used.
- When the staple function or the punch function is disabled in the machine's system settings (administrator), stapling or punching is not possible.
- For information on pamphlet stapling, see "[CREATING A PAMPHLET \(Pamphlet/Pamphlet Staple\)](#)" (page 22).

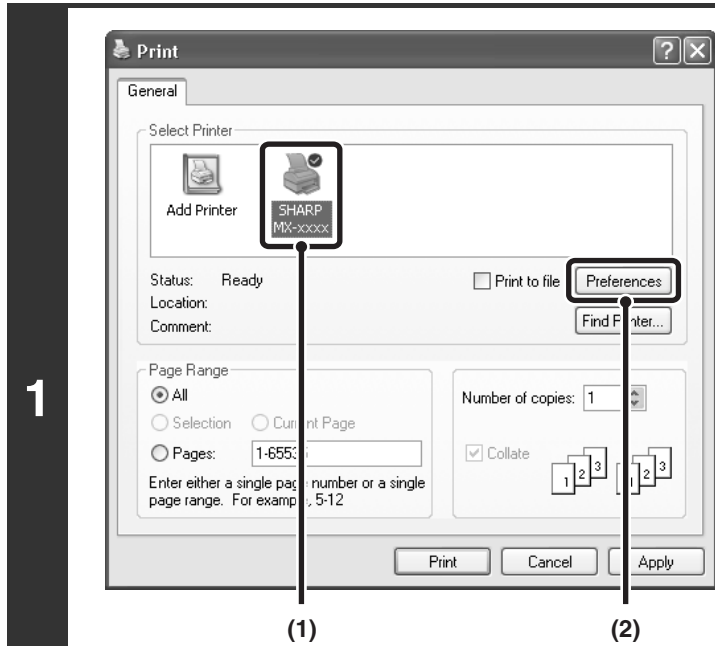

Open the printer driver properties window from the print window of the software application.

- (1) Select the printer driver of the machine.
- (2) Click the [Preferences] button.

The button that is used to open the printer driver properties window (usually [Properties] or [Printing Preferences]) may vary depending on the software application.

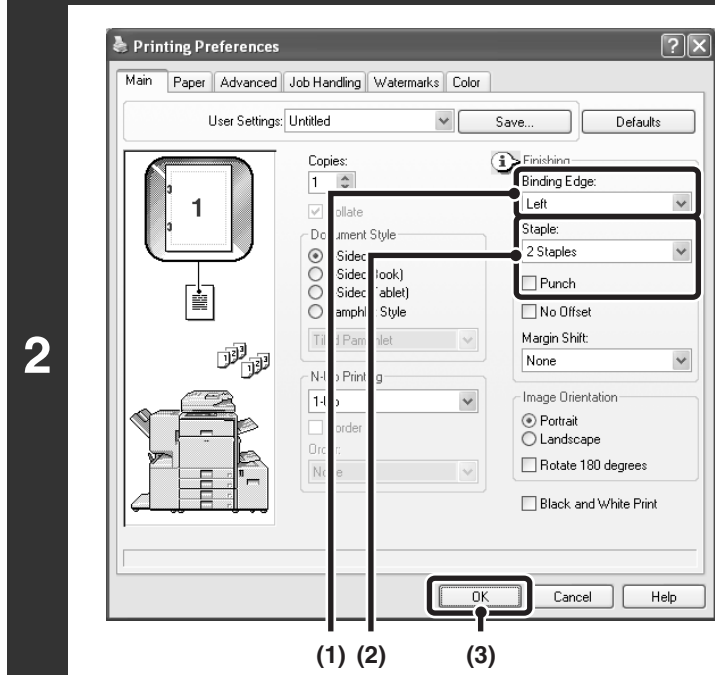

Select the staple function or the punch function.

- (1) Select the binding edge.
- (2) Select the staple function or the punch function.
 - For the staple function, select the number of staples in the "Staple" menu.
 - For the punch function, click the [Punch] checkbox so that a checkmark appears.
- (3) Click the [OK] button.

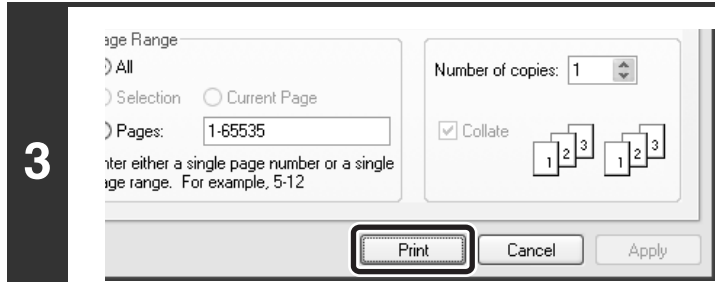

Start printing.

2

CONVENIENT PRINTING FUNCTIONS IN WINDOWS

This section explains convenient functions for specific printing objectives. The procedures for selecting these functions assume that the printer driver properties window has been opened from the print window of your application and that basic settings such as the paper size have been selected. When the settings are completed, return to the print window and begin printing.

 [BASIC PRINTING PROCEDURE](#) (Page 6)



For details on printer driver settings used for each printing function, view printer driver Help.

CONVENIENT FUNCTIONS FOR CREATING PAMPHLETS AND POSTERS

CREATING A PAMPHLET (Pamphlet/Pamphlet Staple)

The pamphlet function prints on the front and back of each sheet of paper so that the sheets can be folded and bound to create a pamphlet. This is convenient when you wish to compile printed output into a pamphlet. When a saddle stitch finisher is installed and saddle stitch printing and the staple function are selected, the output is automatically folded at the centre. This allows you to conveniently use the output as a handout or pamphlet without the need for any further work.

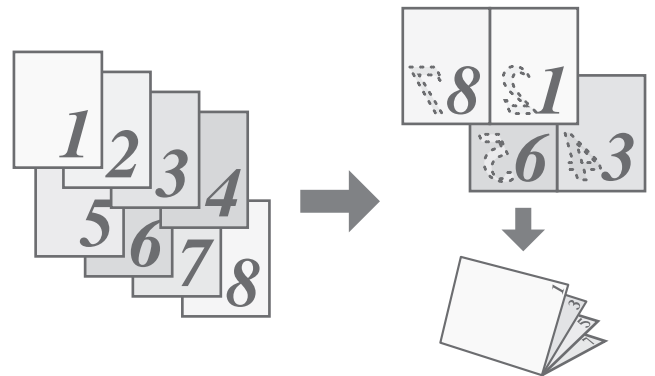

Selecting the settings:

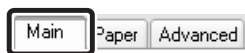

The settings are on the [Main] tab.

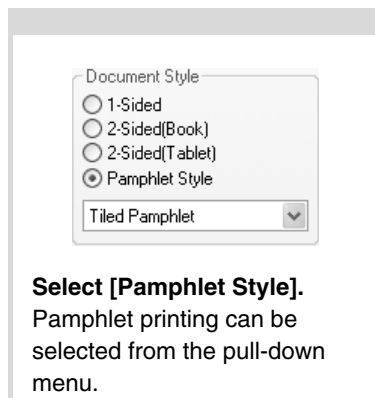

Select [Pamphlet Style]. Pamphlet printing can be selected from the pull-down menu.

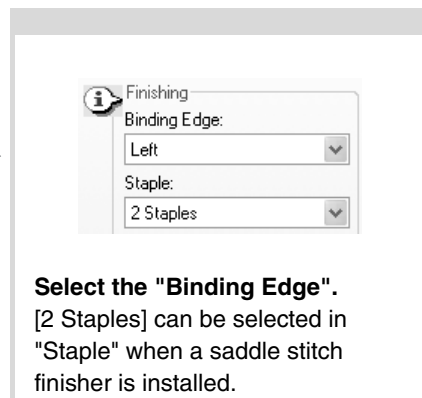

Select the "Binding Edge". [2 Staples] can be selected in "Staple" when a saddle stitch finisher is installed.

INCREASING THE MARGIN (Margin Shift)

This function is used to shift the print image to increase the margin at the left, right, or top of the paper. This is convenient when you wish to staple or punch the output, but the binding position overlaps the text. When a finisher or saddle stitch finisher is installed, you can use the staple function or the punch function with this function.

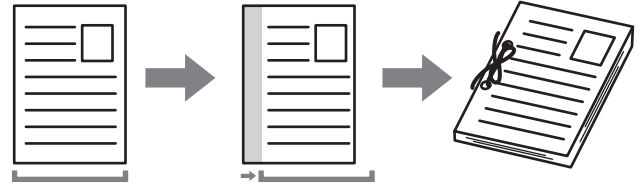

Selecting the settings:

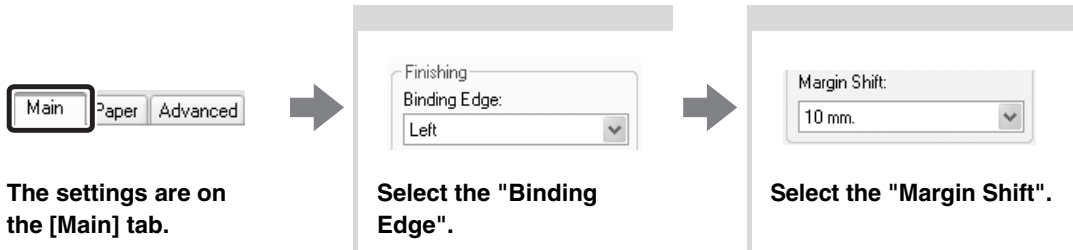

CREATING A LARGE POSTER (Poster Printing)

One page of print data can be enlarged and printed in sections on multiple sheets of paper (4 sheets (2 x 2), 9 sheets (3 x 3) or 16 sheets (4 x 4)). This makes it possible to attach the sheets together to create a large poster. To enable precise alignment of the edges of the sheets during attachment, borderlines can be printed and overlapping edges can be created (overlap function).

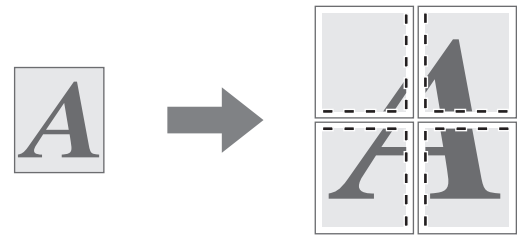

Selecting the settings:

(This function can be used when the SPLC-c, PCL6, or PS printer driver is used.)

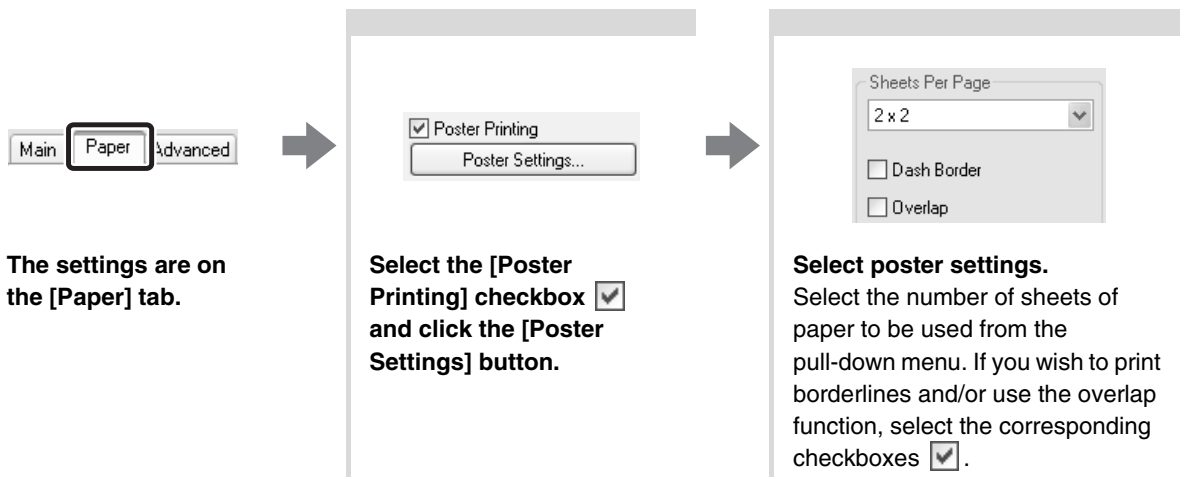

FUNCTIONS TO ADJUST THE SIZE AND ORIENTATION OF DATA

ROTATING THE PRINT IMAGE 180 DEGREES (Rotate 180 degrees)

This feature enables the image to be rotated 180 degrees so that it can be printed correctly on paper that can only be loaded in one orientation (such as envelopes or paper with punch holes).

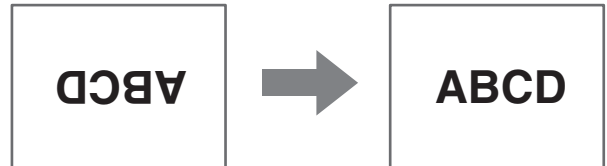

Selecting the settings:

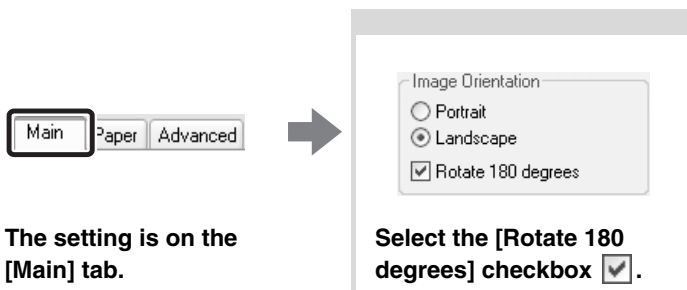

ENLARGEMENT/REDUCTION (Zoom/XY-Zoom)

This function is used to enlarge or reduce the image to a selected percentage. This allows you to add margins to the paper by slightly reducing the image, or to enlarge a small image.

When using the PS printer driver, you can set the width and length percentages separately to change the proportions of the image. (XY-Zoom)

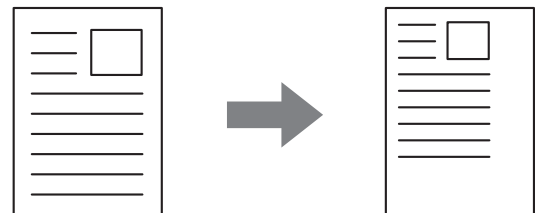

Selecting the settings:

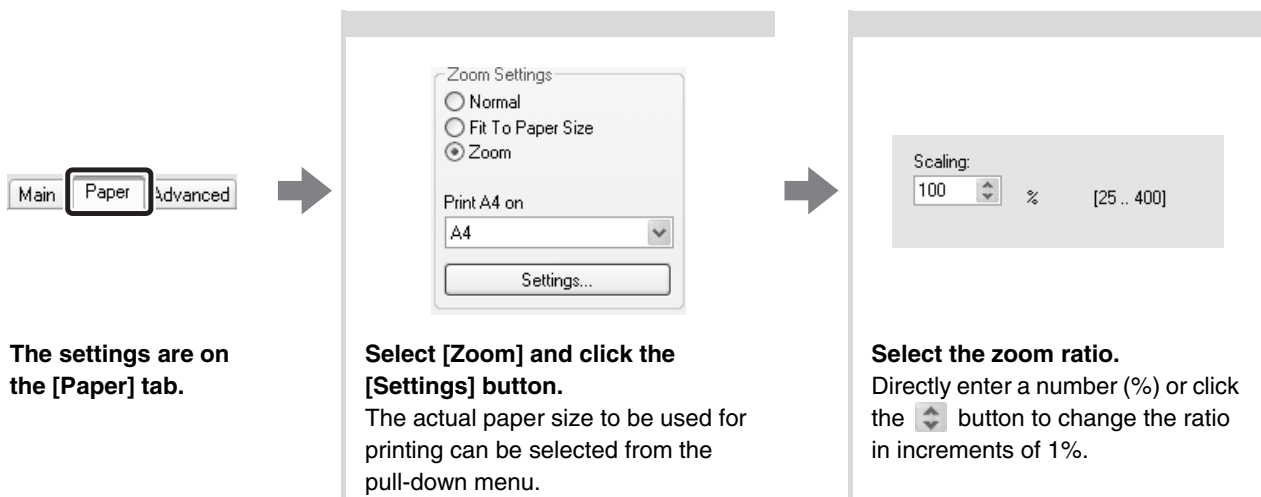

REVERSING THE IMAGE (Mirror Image)

The image can be reversed to create a mirror image.
This function can be used to conveniently print a design
for a woodblock print or other printing medium.

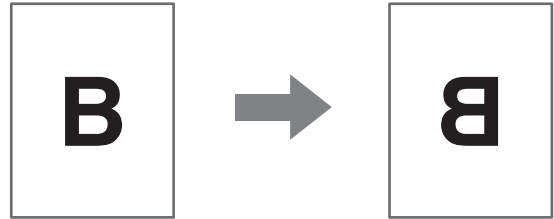

Selecting the settings:

(This function can be used when the PS printer driver is used.)



The settings are on the
[Advanced] tab.

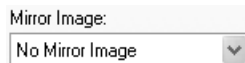

Select the Mirror Image settings.

If you wish to reverse the image
horizontally, select [Horizontal]. If
you wish to reverse the image
vertically, select [Vertical].

COLOUR MODE ADJUSTMENT FUNCTION

ADJUSTING THE BRIGHTNESS AND CONTRAST OF THE IMAGE (Color Adjustment)

The brightness and contrast can be adjusted in the print settings when printing a photo or other image. These settings can be used for simple corrections when you do not have image editing software installed on your computer.

Selecting the settings:

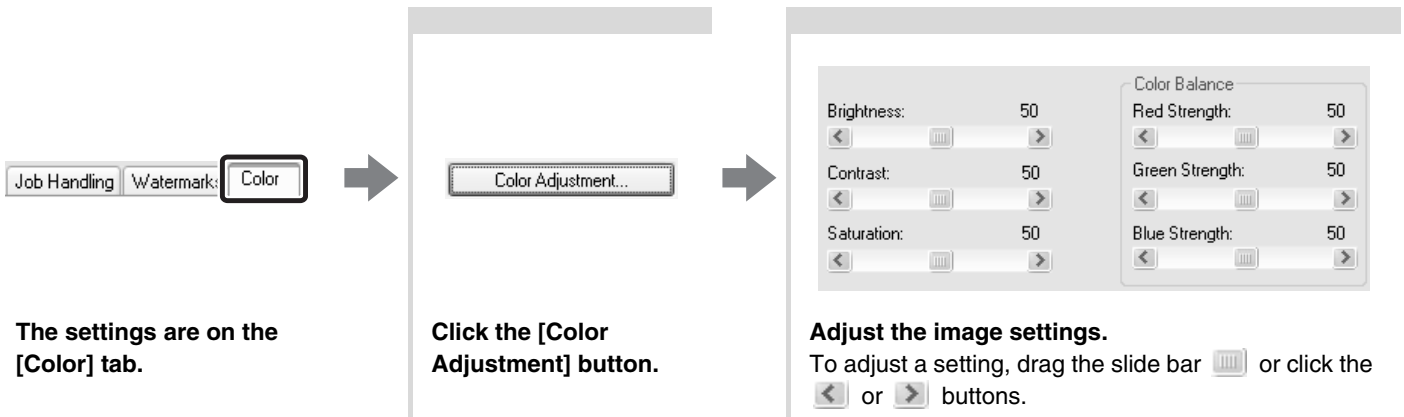

PRINTING LIGHT COLOUR CHARACTERS OR LINES IN BLACK (Text To Black/Vector To Black)

When printing a colour image in greyscale, colour text and lines that are faint can be printed in black. (Raster data such as bitmap images cannot be adjusted.) This allows you to bring out colour text and lines that are faint and difficult to see when printed in greyscale.

- [Text To Black] can be selected to print all text other than white text in black.
- [Vector To Black] can be selected to print all vector graphics other than white lines and areas in black.

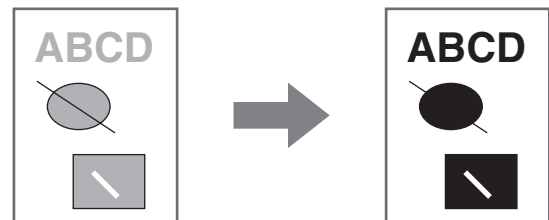

Selecting the settings:

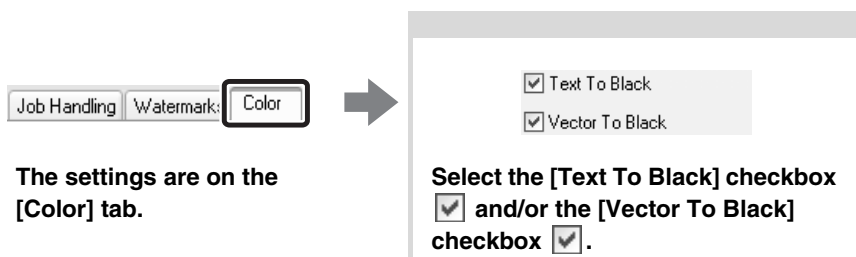

SELECTING COLOUR SETTINGS TO MATCH THE IMAGE TYPE (Image Type)

Preset colour settings are available in the machine's printer driver for [Graphics], [Photo], and other image types. These enable printing using the most suitable colour settings for the colour image type.

If you wish to select advanced settings, click the [Advanced Color] button. The advanced colour settings allow you to configure settings to match the printing purpose of the colour image, such as colour management settings and the screening setting that adjusts the expression of colour tones.

The following items can be configured in the advanced colour management settings:

- [Windows ICM] checkbox: Colour management method
- "Source Profile": Select the colour profile used to display the image on the computer screen.
- "Rendering Intent": Standard value used when converting the colour balance of the image displayed on the computer screen to a colour balance that can be printed by the machine.
- "Screening": Select the most suitable image processing method for the image being printed.
- "Neutral Gray"*: Select the toner colour used to print grey areas.
- "Print Priority"*: Select whether you wish to give priority to image quality or speed when printing.

* This setting is not available in the SPLC-c printer driver.

Selecting the settings:

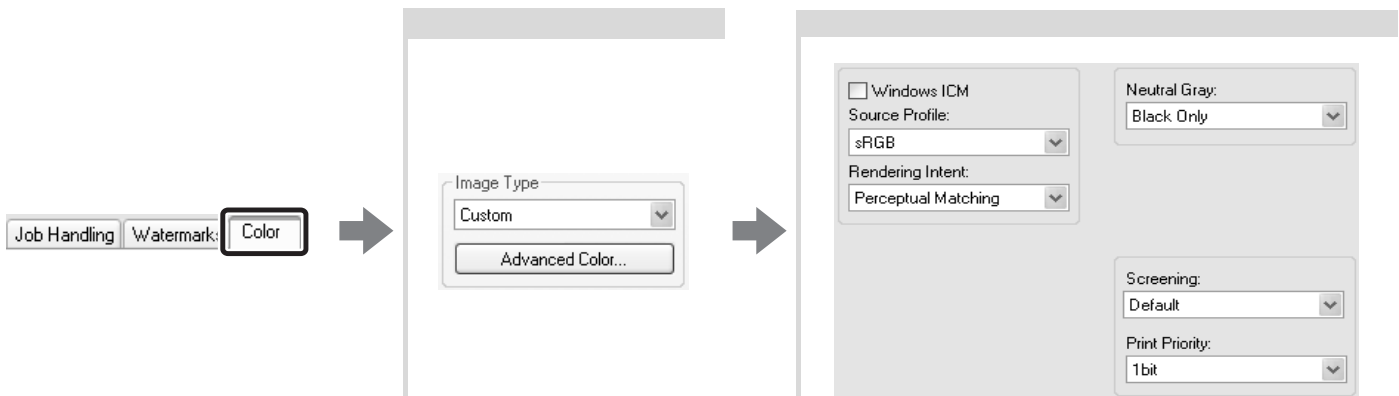

The settings are on the [Color] tab.

Select the color image type.
A document type to match your purpose can be selected from the pull-down menu. If you wish to select advanced settings, click the [Advanced Color] button.

Select the advanced colour settings.
If you wish to perform colour management using Windows ICM in your operating system, select the [Windows ICM] checkbox . To configure advanced colour management settings such as "Source Profile", select the desired settings from the menus.

 To configure all the advanced colour settings, select [Custom] from the pull-down menu and then click the [Advanced Color] button.

 The settings that can be selected vary depending on the printer driver type. The PS printer driver also allows you to select the Black Overprint function, which prevents whitening of the outline of black text, and the CMYK Simulation function, which allows you to perform colour adjustment to obtain a result similar to that of the process colour ([Default] is set to "SWOP" for Northern America or "Euroscale" for other countries.) ink used by a printing press.

FUNCTIONS THAT COMBINE TEXT AND IMAGES

ADDING A WATERMARK TO PRINTED PAGES (Watermark)

Faint shadow-like text can be added to the background of the printed image as a watermark. The size, colour, density, and angle of the watermark text can be adjusted. The text can be selected from a pre-stored list, or entered to create an original watermark.

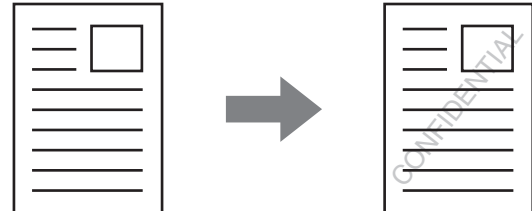

Selecting the settings:

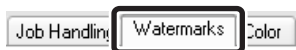

The settings are on the [Watermarks] tab.

A screenshot of a 'Watermark' settings dialog box. It features a pull-down menu with 'None' selected, 'Add' and 'Delete' buttons, a 'Text:' label above a text input field, and an 'Edit...' button.

Select the watermark setting.
Select a stored water mark from the pull-down menu. You can click the [Edit] button to edit the font colour and select other detailed settings.

 **If you wish to create a new watermark...**
Enter the text of the watermark in the text box and click the [Add] button.

PRINTING AN IMAGE OVER THE PRINT DATA (Image Stamp)

A bitmap or JPEG image stored on your computer can be printed over the print data. The size, position, and angle of the image can be adjusted. This feature can be used to "stamp" the print data with a frequently used image or an icon of your own creation.

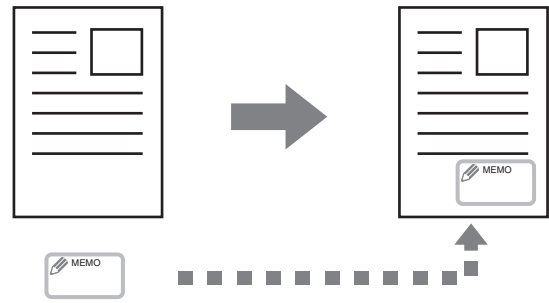

Selecting the settings:

(This function can be used when the SPLC-c, PCL6, or PS printer driver is used.)



The settings are on the [Watermarks] tab.

Select the image stamp setting.
Select a stored image stamp from the pull-down menu.

 **If you wish to create a new image stamp...**
Select an image file and then click the [Add] button.

CREATING OVERLAYS FOR PRINT DATA (Overlays)

The print data can be printed in a previously created overlay. By creating table rulings or a decorative frame in an application different from the text and registering the data as an overlay file, an attractive print result can be easily obtained without the need for complex manipulations.

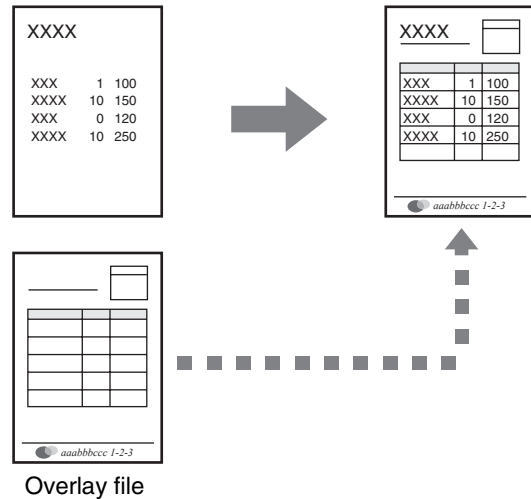

Selecting the settings:

(This function can be used when the PCL6, PCL5c, or PS printer driver is used.)

Create an overlay file

Paper **Advanced** Job Handling

The settings are on the [Advanced] tab.
Configure the printer driver settings from the software application used to create the overlay file.

Overlays
No Overlay
Edit...

Click the [Edit] button.

Overlays
No Overlay
Load Overlay...
Create Overlay...
Delete
 Query Page Overlay

Create an overlay file.
Click the [Create Overlay] button and specify the name and folder to be used for the overlay file that you wish to create. The file will be created when the settings are completed and printing is started.

- When printing is started, a confirmation message will appear. The overlay file will not be created until the [Yes] button is clicked.
- To register a previously existing overlay file, click the [Load Overlay] button.

Print with an overlay file

Paper **Advanced** Job Handling

The settings are on the [Advanced] tab.
Configure the printer driver settings from the application that you wish to use to print using the overlay file.

Overlays
No Overlay
Edit...

Select the overlay file.
A previously created or stored overlay file can be selected from the pull-down menu.

PRINT FUNCTIONS FOR SPECIAL PURPOSES

Print functions for special purposes can be found in the "Special Option" field on the [Paper] tab of the printer driver properties window.

Click the [Settings] button to display the setting screen of the selected print function.



- Select [Normal] when you do not wish to use a print function in "Special Option".
- The functions that are available vary depending on the printer driver type.

PRINTING SPECIFIED PAGES ON DIFFERENT PAPER (Different Paper)

The front and back cover and specified pages of a document can be printed on paper that is different from the other pages. Use this function when you wish to print the front and back cover on heavy paper, or insert coloured paper or a different paper type at specified pages. You can also insert paper as an insert without printing on it. (Only a cover can be inserted when the SPLC-c printer driver is used.)

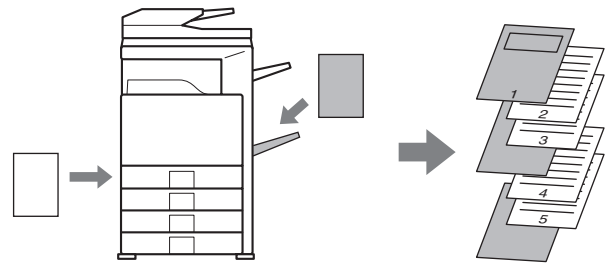

Selecting the settings:



The settings are on the [Paper] tab.

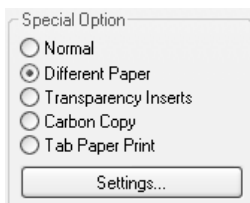

Select [Different Paper] and click the [Settings] button.

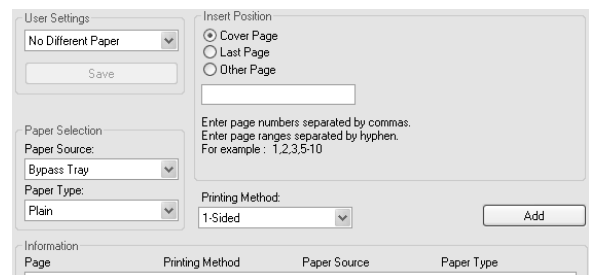

Select insert settings

The paper setting, insertion position, and printing method can be selected. Settings configured here can be added by clicking the [Add] button. Saved settings can be checked in the "Information" list. Settings are added to this list when they are saved. When you have completed the settings, click the [Save] button.



When [Bypass Tray] is selected in "Paper Source", be sure to select the "Paper Type".

ADDING INSERTS WHEN PRINTING ON TRANSPARENCY FILM (Transparency Inserts)

When printing on transparency film, this function helps prevent the sheets of transparency film from sticking together by inserting a sheet of paper between each sheet of film. It is also possible to print the same content on each inserted sheet of paper as is printed on the corresponding sheet of transparency film.

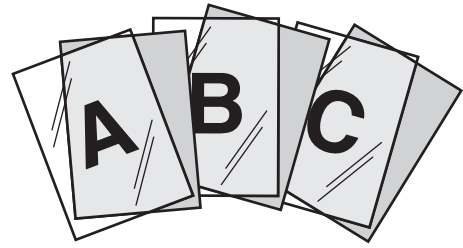

Selecting the settings:

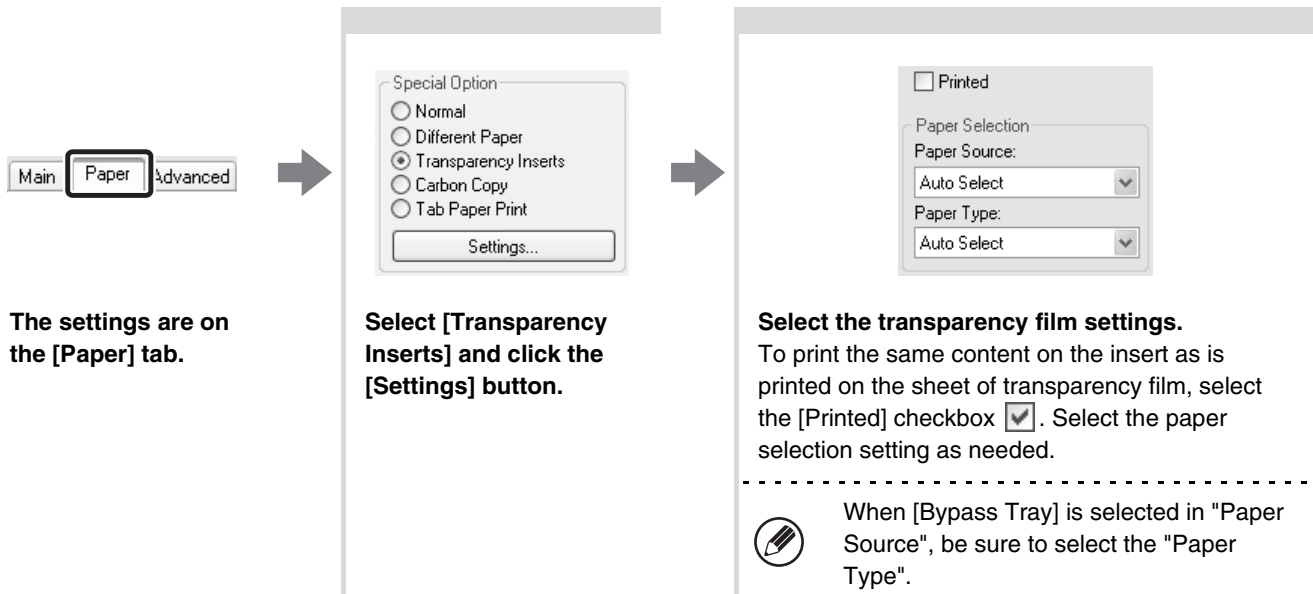

The settings are on the [Paper] tab.

Select [Transparency Inserts] and click the [Settings] button.

Select the transparency film settings. To print the same content on the insert as is printed on the sheet of transparency film, select the [Printed] checkbox . Select the paper selection setting as needed.

 When [Bypass Tray] is selected in "Paper Source", be sure to select the "Paper Type".

PRINTING A CARBON COPY (Carbon Copy)

This function is used to print an additional copy of the print data on paper that is the same size but from a different paper tray.

For example, if carbon copy print is selected when standard paper is loaded in tray 1 and coloured paper is loaded in tray 2, a print result similar to a carbon copy slip can be obtained by selecting the print command only once. As another example, if standard paper is loaded in tray 1 and recycled paper is loaded in tray 2, Carbon Copy can be used to simultaneously print one copy for presentation and one copy as a duplicate.

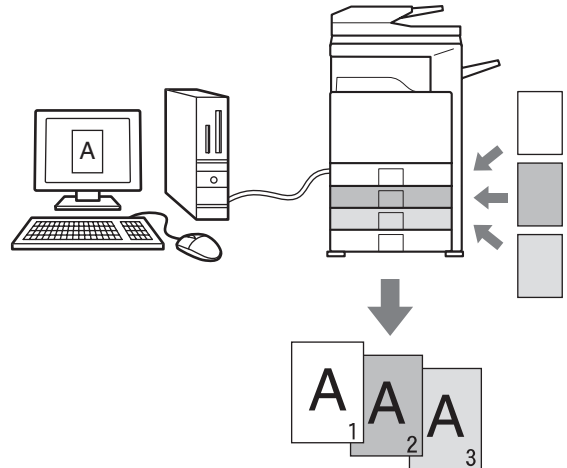

Selecting the settings:

(This function can be used when the PCL6, PCL5c, or PS printer driver is used.)

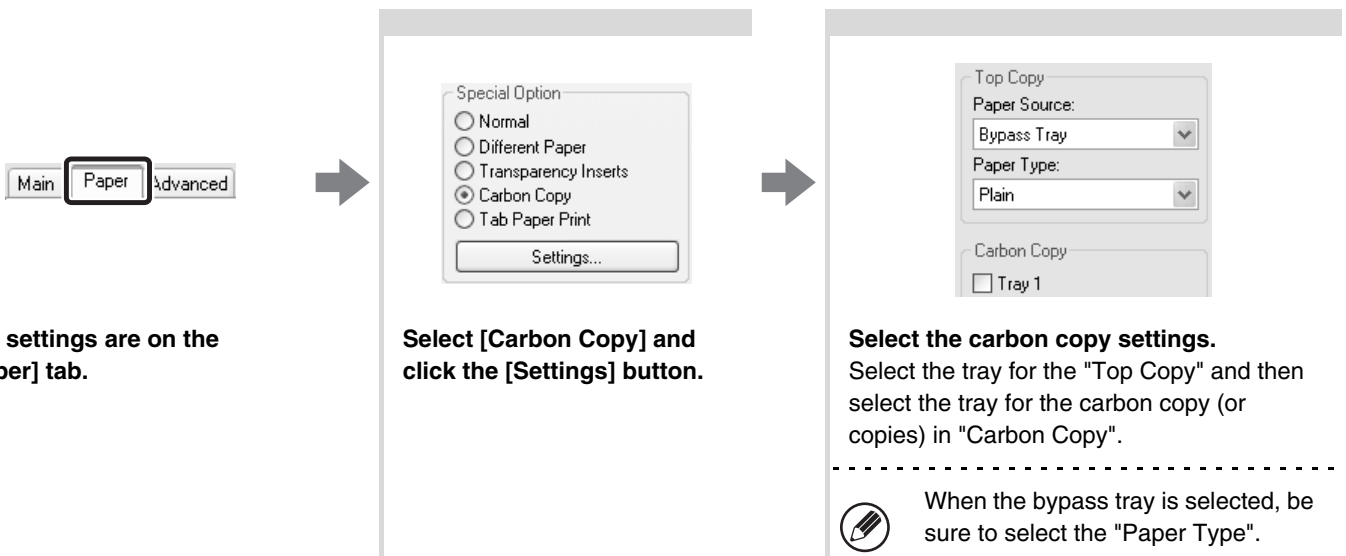

PRINTING TEXT ON TABS OF TAB PAPER (Tab Printing)

This function is used to print text on the tabs of tab paper.

Printing tab data created in the printer driver (PCL6 only)

Enter the text to be printed on the tabs in [Tab Paper Print] on the [Paper] tab of the printer driver properties window, and configure detailed settings such as the size of the tabs, the starting position, the distance between tabs, and the page numbers where tab sheets will be inserted.

Printing tab data created in a software application (PCL6, PCL5c, PS only)

After creating the text to be printed on the tabs in a software application, use [Tab Paper Settings] on the [Advanced] tab of the printer driver properties window to specify how far the text needs to be shifted for tab printing.

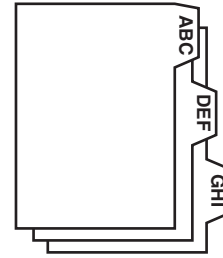

Selecting the settings:

Printing tab data created in the printer driver (PCL6 only)

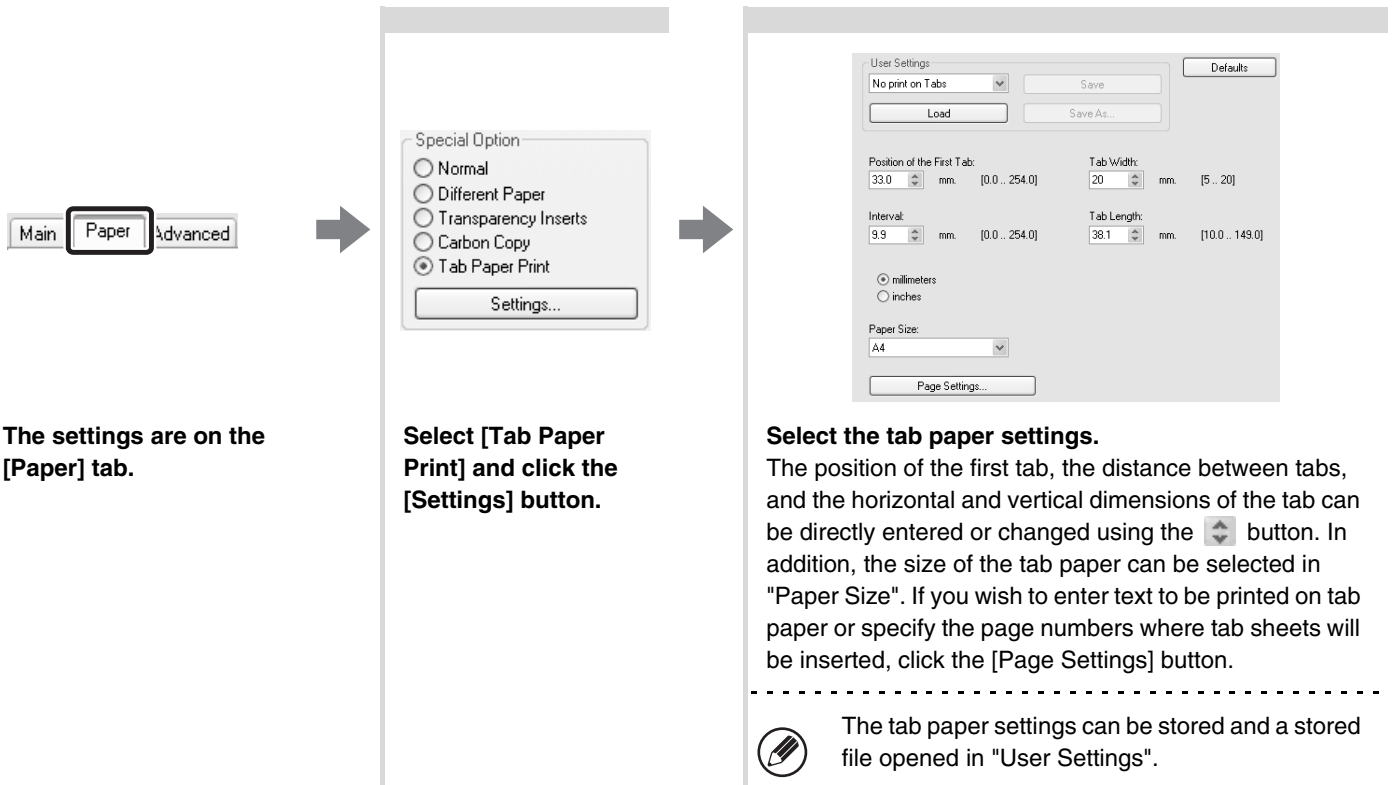

The settings are on the [Paper] tab.

Select [Tab Paper Print] and click the [Settings] button.

Select the tab paper settings.

The position of the first tab, the distance between tabs, and the horizontal and vertical dimensions of the tab can be directly entered or changed using the  button. In addition, the size of the tab paper can be selected in "Paper Size". If you wish to enter text to be printed on tab paper or specify the page numbers where tab sheets will be inserted, click the [Page Settings] button.

 The tab paper settings can be stored and a stored file opened in "User Settings".

Printing tab data created in a software application (PCL6, PCL5c, PS only)

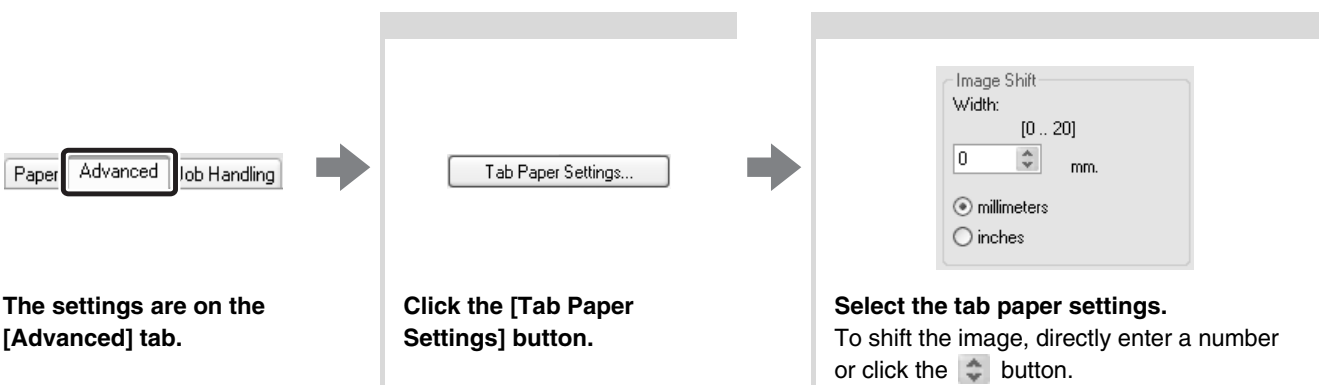

The settings are on the [Advanced] tab.

Click the [Tab Paper Settings] button.

Select the tab paper settings.

To shift the image, directly enter a number or click the  button.

CONVENIENT PRINTER FUNCTIONS

USING TWO MACHINES TO PRINT A LARGE PRINT JOB (Tandem Print)

Two machines are required to use this function. Tandem Print allows you to divide a large print job between two machines connected to your network. The machines simultaneously print each half of the job, making it possible to shorten the printing time when printing a large number of sets.

To use Tandem Print, the IP address of the slave machine configured in "Tandem Connection Setting" of the machine's system settings (administrator) must be configured in the printer driver. This can be accomplished automatically by clicking the [Auto Configuration] button on the [Configuration] tab of the printer driver.

Tandem Print can only be used when the printer driver is installed using a "Standard installation" or a "Custom installation" with "LPR Direct Print" selected.

Example: Printing 4 sets of copies

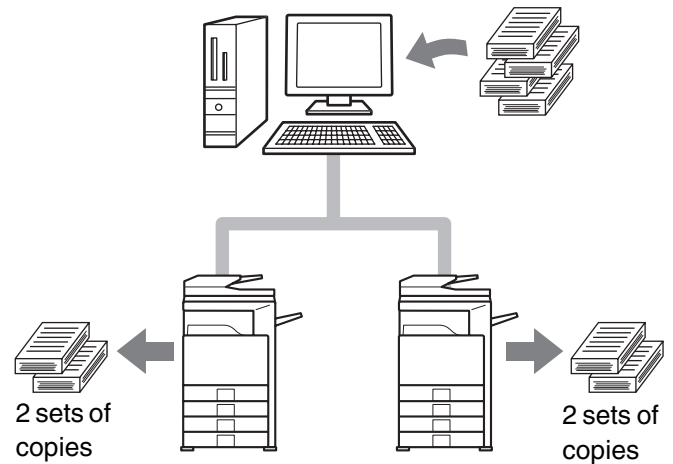

Selecting the settings:

(This function can be used when the PCL6, PCL5c, or PS printer driver is used.)



The setting is on the [Advanced] tab.



Tandem Print

Select the [Tandem Print] checkbox .

USING THE DOCUMENT FILING FUNCTION (Retention/Document Filing)

This function is used to store a print job as a file on the machine's hard drive, allowing the job to be printed from the operation panel when needed. You can select a folder to keep the file from being mixed together with files of other users, and a password (from 5 to 8 digits number) can be established to prevent others from accessing the file.

To print a file stored with a password, the password must be entered on the machine.

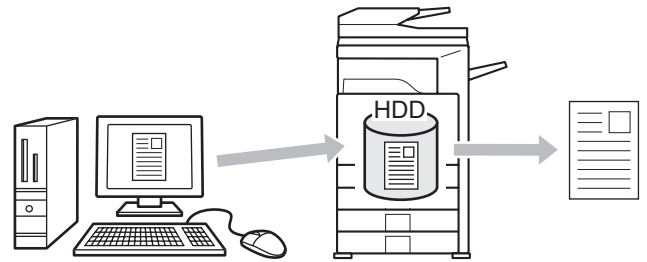

Hold Only

This setting is used to hold a print job on the machine's hard drive without printing it.

Hold After Print

This setting is used to hold a print job on the machine's hard drive after it is printed.

Sample Print

When a print job is sent to the machine, only the first set of copies is printed. After checking the contents of the first set of copies, you can print the remaining sets from the operation panel of the machine. This prevents the occurrence of excessive misprints.

To print files stored on the machine's hard drive, see the Document Filing Guide.

Selecting the settings:

The screenshot shows a settings menu with three tabs: 'Advanced', 'Job Handling', and 'Watermarks'. The 'Job Handling' tab is highlighted with a black border.

The settings are on the [Job Handling] tab.

Select the retention setting.
Select the [Retention] checkbox and then select the retention method for the print job in "Retention Settings". To enter the password (from 5 to 8 digits number), click a [Password] checkbox .

Select document filing settings.
Select the folder for storing the file in "Document Filing Settings". If you selected [Custom Folder], click the [Stored to] button to select the folder.

- When [Quick File] is selected, "Retention Settings" will be set to [Hold After Print] only.
- When [Quick File] is selected, the password entered in "Retention Settings" is cleared and cannot be used.
- To store a file in a custom folder, the custom folder must first be created using "Document Filing Control" in the system settings (administrator). If a password has been established for a custom folder, enter the "Folder Password" in the folder selection screen.

SAVING FREQUENTLY USED PRINT SETTINGS

Settings configured on each tab at the time of printing can be saved as user settings. Saving frequently used settings or complex colour settings under an assigned name makes it easy to select those settings the next time you need to use them.

SAVING SETTINGS AT THE TIME OF PRINTING

Settings can be saved from any tab of the printer driver properties window. Settings configured on each tab are listed at the time of saving, allowing you to check the settings as you save them.

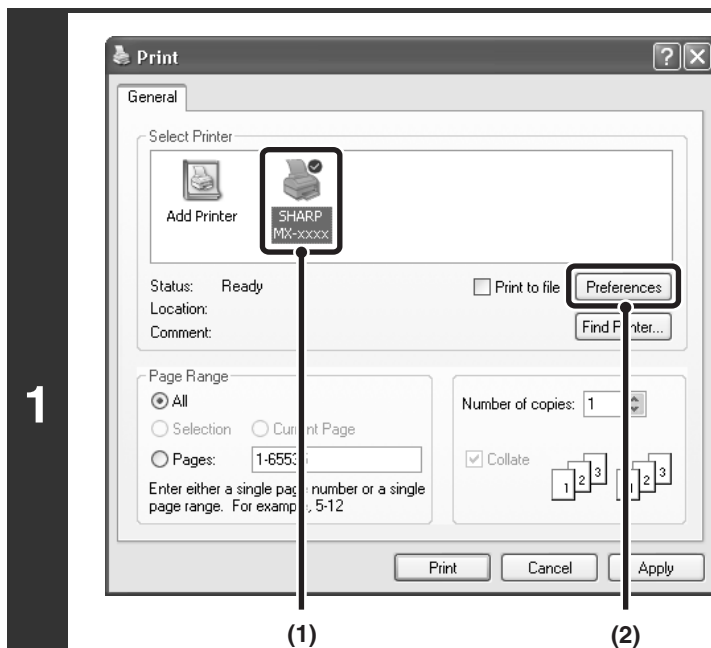

Open the printer driver properties window from the print window of the software application.

- (1) Select the printer driver of the machine.
- (2) Click the [Preferences] button.



The button that is used to open the printer driver properties window (usually [Properties] or [Printing Preferences]) may vary depending on the software application.

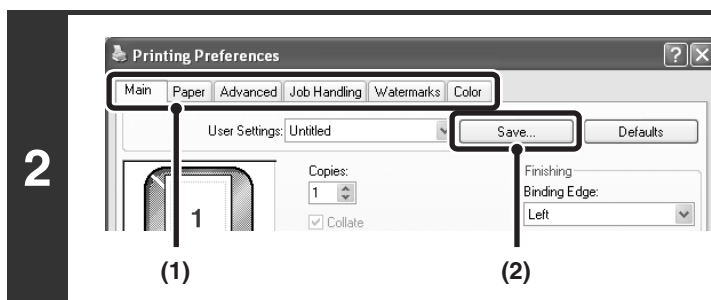

Save the print settings.

- (1) Configure print settings on each tab.
- (2) Click the [Save] button.

3

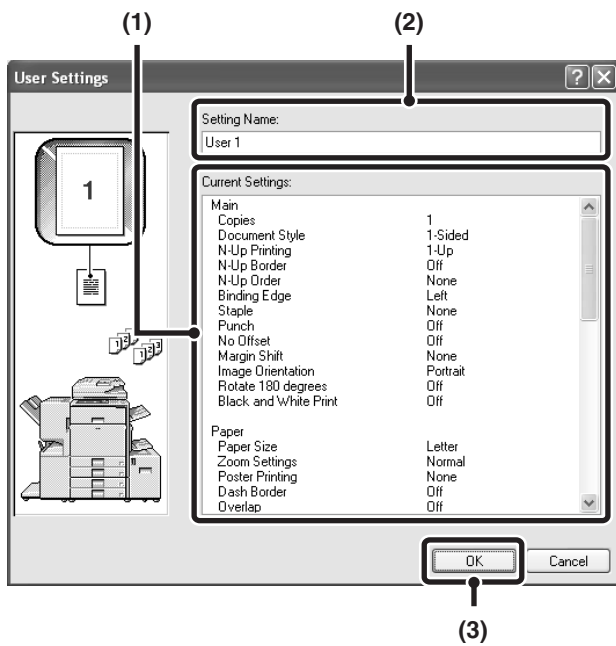

Check and save the settings.

- (1) Check the displayed settings.
- (2) Enter a name for the settings (maximum of 20 characters).
- (3) Click the [OK] button.

4



Click the [OK] button.

5

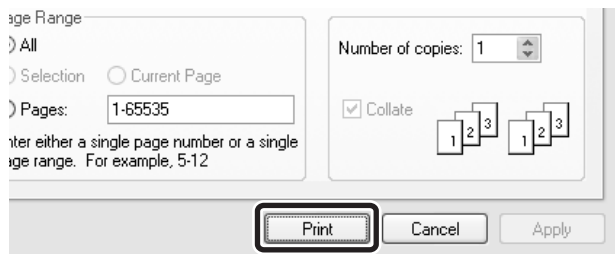

Start printing.



- Up to 30 sets of user settings can be saved.
- The following items cannot be saved in user settings.
 - A watermark that you created
 - Paper insertion settings
 - Overlay file
 - [Tab Paper Print] settings on the [Paper] tab (PCL6 only)
 - The login name, password, user name, and job name entered in the [Job Handling] tab

USING SAVED SETTINGS

1

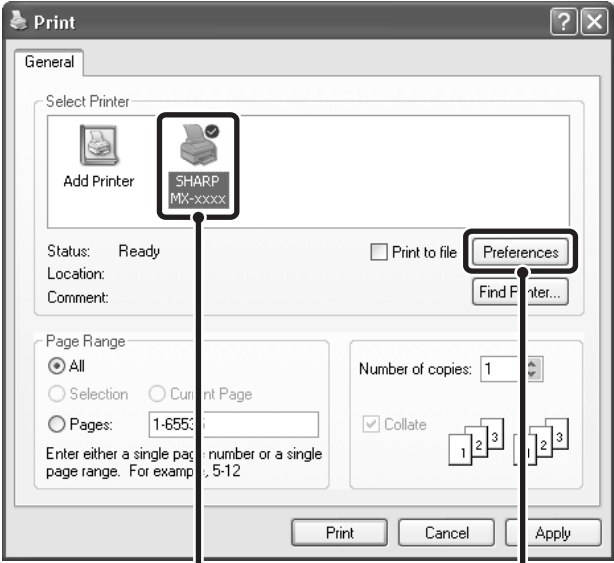

Open the printer driver properties window from the print window of the software application.

- (1) Select the printer driver of the machine.
- (2) Click the [Preferences] button.

 The button that is used to open the printer driver properties window (usually [Properties] or [Printing Preferences]) may vary depending on the software application.

2

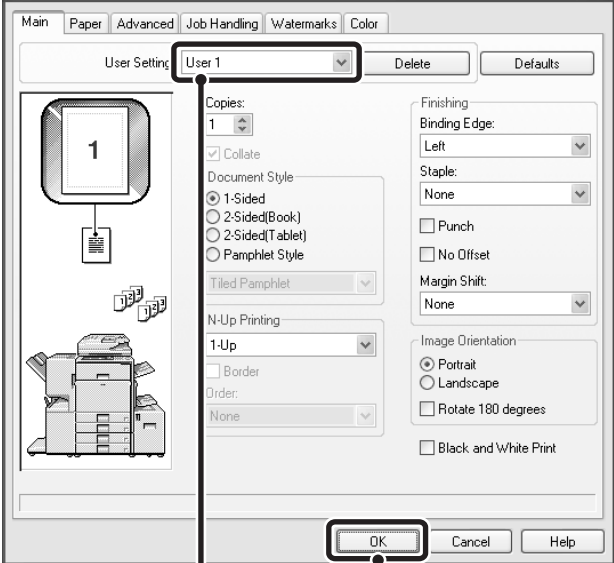

Select the print settings.

- (1) Select the user settings that you wish to use.
- (2) Click the [OK] button.

3



Start printing.

Deleting saved settings

Select the user settings that you want to delete in step 2 above, and click the [Delete] button.

CHANGING THE PRINTER DRIVER DEFAULT SETTINGS

The default settings of the printer driver can be changed using the procedure below. The settings selected using this procedure are saved and become the default settings when printing from a software application. (Settings selected in the printer driver properties window when printing from an application remain in effect only while the application is in use.)

1

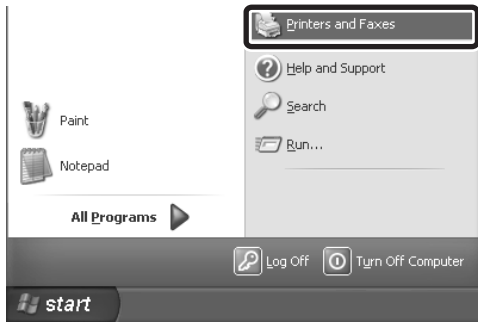

Click the [start] button and then click [Printers and Faxes].

In Windows 98/Me/NT 4.0/2000, click the [Start] button, point to [Settings], and then select [Printers].



In Windows XP, if [Printers and Faxes] does not appear in the [start] menu, select [Control Panel], select [Printers and Other Hardware], and then select [Printers and Faxes].

2

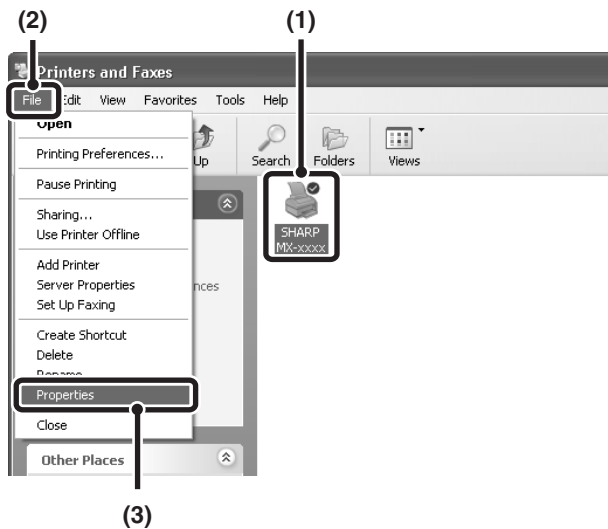

Open the printer properties window.

(1) Click the icon of the printer driver of the machine.

(2) Click the [File] menu.

(3) Select [Properties].

In Windows NT 4.0, select [Document Defaults] from the [File] menu to open the printer driver properties window. Go to step 4.

3

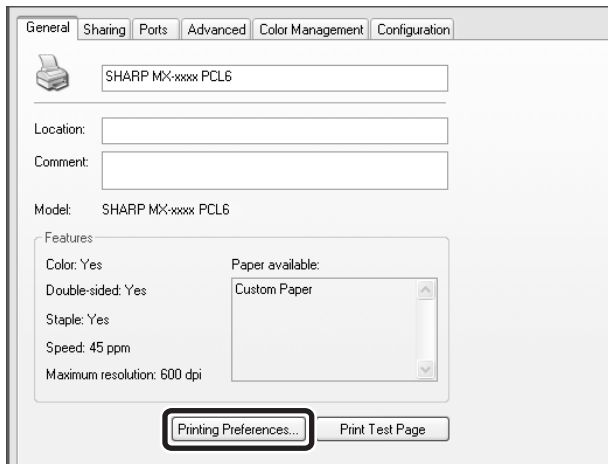

Click the [Printing Preferences] button on the [General] tab.

In Windows 98/Me, click the [Setup] tab.

4

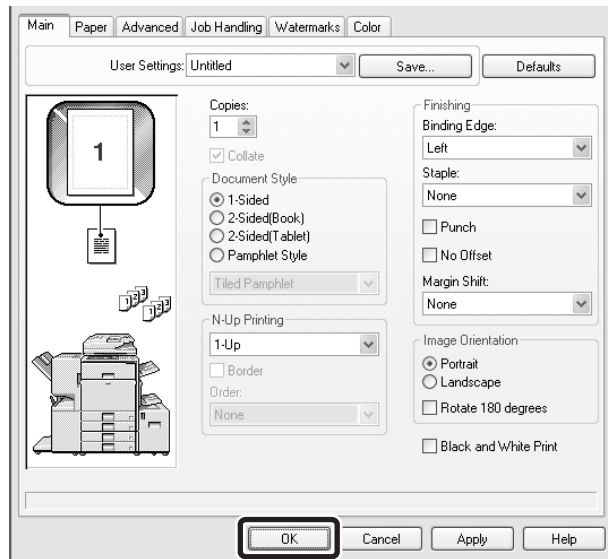

Configure the settings and click the [OK] button.

For explanations of the settings, see printer driver Help.

3

PRINTING FROM A MACINTOSH

BASIC PRINTING PROCEDURE

The following example explains how to print a document from "TextEdit", which is a standard accessory program in Mac OS X.

 The PS3 expansion kit is required to use the machine as a printer in a Macintosh environment. (On the MX-2300G/2700G, the printer expansion kit must also be installed.) In addition, the printer function can only be used when the machine is connected to a network. To install the PPD file and configure the printer driver settings, see the Software Setup Guide.

SELECT PAPER SETTINGS

Select paper settings in the printer driver before selecting the print command.

1



Select [Page Setup] from the [File] menu of TextEdit.

2

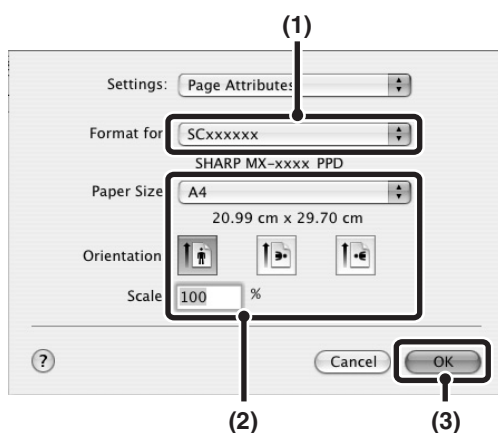

Select paper settings.

(1) Make sure that the correct printer is selected.

(2) Select paper settings.

The paper size, paper orientation, and enlarge/reduce can be selected.

(3) Click the [OK] button.



- The machine name that appears in the "Format for" menu is normally [SCxxxxxx]. ("xxxxxx" is a sequence of characters that varies depending on your machine model.)
- The contents of the screen and procedures for changing the settings vary depending on your operating system version, the printer driver version, and the software application.

PRINT

1

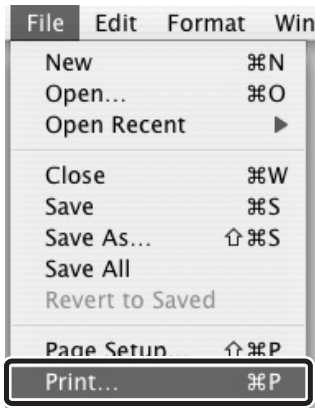

Select [Print] from the [File] menu of TextEdit.

2

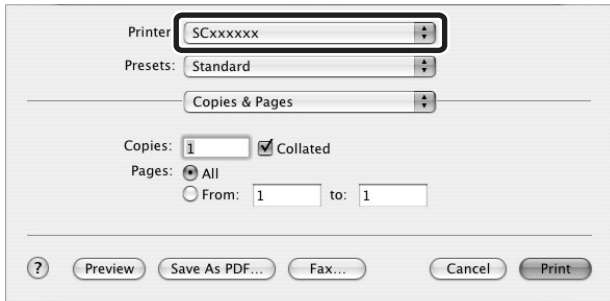

Make sure that the correct printer is selected.



- The machine name that appears in the "Printer" menu is normally [SCxxxxxx]. ("xxxxxx" is a sequence of characters that varies depending on the machine model.)
- The print window varies depending on the operating system version, the printer driver version, and the application.

3

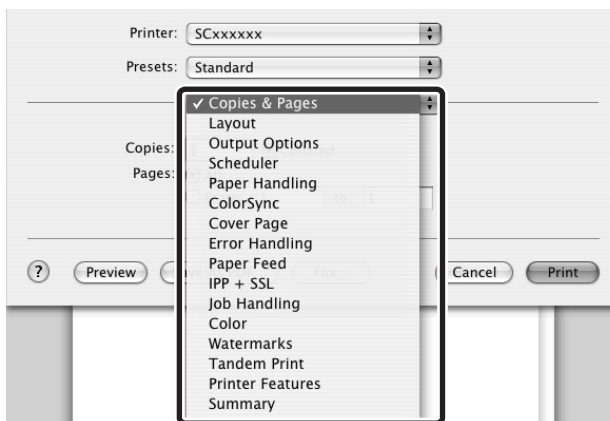

Select print settings.

Click [▼] next to [Copies & Pages] ([General] in Mac OS 9.0 to 9.2.2) and select the settings that you wish to configure from the pull-down menu. The setting screen of each selected setting will appear.



- The settings vary depending on the operating system version, the printer driver version, and the application.

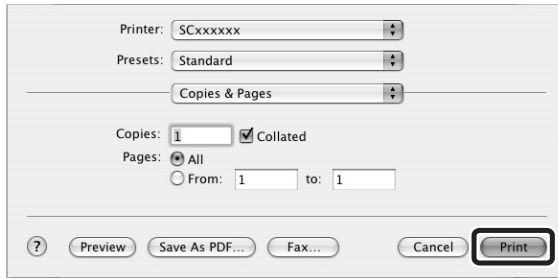

Printer: SCxxxxxx

Presets: Standard

Copies & Pages

Copies: 1 Collated

Pages: All
 From: 1 to: 1

? Preview Save As PDF... Fax... Cancel **Print**

Click the [Print] button.

Printing begins.



The print job is delivered to the output tray, with the position of the paper offset slightly from the previous job (other than the right tray).

SELECTING THE PAPER

This section explains the [Paper Feed] settings ([Paper Source] setting in "General" in Mac OS 9.0 to 9.2.2) in the print settings window.

- **When [Auto Select] is selected**

A tray with plain paper or recycled paper (the factory default setting is plain paper only) of the size specified in "Paper Size" in the page settings window is automatically selected.

- **When a paper tray is selected**

The specified tray is used for printing regardless of the "Paper Size" setting in the page settings window. A paper type can also be specified for the bypass tray. Check the bypass tray and make sure that the desired type of paper is loaded, and then select the appropriate paper type setting for the bypass tray.



- Special media such as envelopes can also be placed in the bypass tray. For the procedure for loading paper and other media in the bypass tray, see "LOADING PAPER IN THE BYPASS TRAY" in the User's Guide.
- When "Enable Detected Paper Size in Bypass Tray" (disabled by factory default) or "Enable Selected Paper Type in Bypass Tray" (enabled by factory default) is enabled in the system settings (administrator), printing will not take place if the paper size or paper type specified in the printer driver is different from the paper size or paper type specified in the settings of the bypass tray.

- **When a paper type is selected**

A tray with the specified type of paper and the size specified in "Paper Size" in the page settings window is used for printing.



System Settings (Administrator): Exclude Bypass-Tray from Auto Paper Select

When [Auto Select] is selected, specify whether or not the paper in the bypass tray will be excluded from the paper that can be automatically selected. This setting is disabled by factory default, and thus paper in the bypass tray is included in the paper that can be automatically selected. If special types of paper are frequently loaded in the bypass tray, it is recommended that this setting be enabled.

PRINTING WHEN THE USER AUTHENTICATION FUNCTION IS ENABLED

When the user authentication function is enabled in the machine's system settings (administrator), your user information (login name, password, etc.) must be entered when you print. The information that must be entered varies depending on the authentication method being used, so check with the administrator of the machine before printing.

1



Select [Print] from the application's [File] menu.



The menu used to execute printing may vary depending on the software application.

2

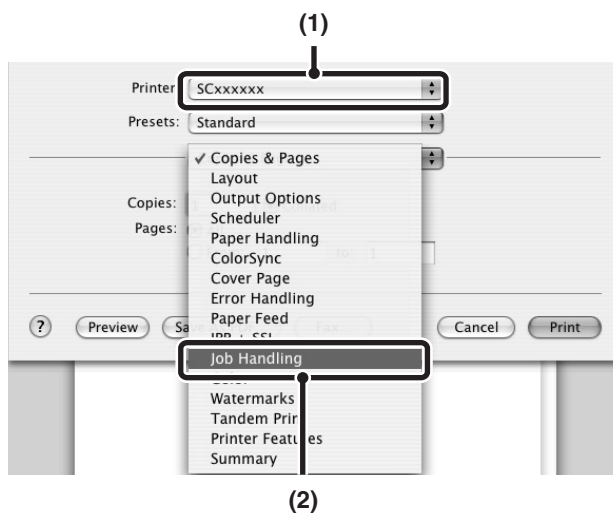

Display the job handling screen.

(1) Make sure that the machine's printer name is selected.

(2) Select [Job Handling].

In Mac OS 9.0 to 9.2.2, select [User Authentication].



- The machine name that appears in the "Printer" menu is normally [SCxxxxxx]. ("xxxxxx" is a sequence of characters that varies depending on the machine model.)
- The print window varies depending on the operating system version, the printer driver version, and the application.

Printer: SCxxxxxx
 Presets: Standard
 Job Handling

Retention

Retention Settings

Hold Only
 Hold After Print
 Sample Print

Password:

Document Filing Settings

Quick File
 Main Folder
 Custom Folder

Stored to...

User Authentication
 Login Name:
 Password:
 User Number

Job ID

User Name:
 Job Name:

? Preview Save As Pl... Fax... Cancel **Print**

(1) (2)

Start printing.

(1) Enter your user information.

- **When authentication is by login name/password**
Enter your login name in "Login Name" and your password in "Password" (1 to 32 characters).
- **When authentication is by user number**
Enter your user number (5 to 8 digits) in "User Number".

(2) Click the [Print] button.



You can click the (lock) button after entering your login name and password, or user number, to simplify operation the next time you wish to print based on the same user authentication.



- Normally printing is possible without entering your user information. (In this case, the printed pages will be added to the "Others" count.) When printing by invalid users is prohibited in the system settings (administrator), printing is not permitted when user information is not entered or incorrect information is entered.
- If you are using Mac OS X v10.1.5, the user authentication function of the machine is not available. For this reason, printing will not be possible if printing by invalid users is prohibited in the system settings (administrator).



System Settings (Administrator): Disable Printing by Invalid User

This is used to prohibit printing of print jobs by users whose user information is not stored in the machine. When this function is enabled, printing is not allowed when user information is not entered or incorrect information is entered.

4

PRINTING WITHOUT THE PRINTER DRIVER

When you do not have the printer driver installed on your computer, or when the software application used to open a file that you wish to print is not available, you can print directly to the machine without using the printer driver. The file types (and corresponding extensions) that can be printed directly are shown below.

File Type	TIFF	JPEG	PCL	PDF/ Encrypted PDF	PS
Extension	tiff, tif	jpeg, jpg, jpe, jif	pcl	pdf	ps



- Print data that includes images are counted as colour even though the data is black and white. To be always counted and printed as black and white, select black and white printing.
- To use these functions on the MX-2300G/2700G, the printer expansion kit must be installed.
- To print PDF and PS files, the PS3 expansion kit must be installed.
- Depending on the file type, it may not be possible to print some files in the above table.

DIRECTLY PRINTING FROM THE MACHINE

A file on an FTP server or in a USB memory device connected to the machine can be selected and printed from the operation panel of the machine without using the printer driver.

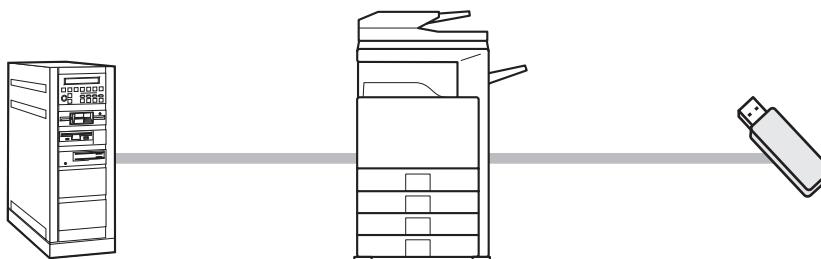

DIRECTLY PRINTING A FILE ON AN FTP SERVER

When an FTP server is configured in the machine's Web page, you can specify and print a file on the FTP server from the operation panel of the machine. This saves you the trouble of downloading the file and printing it from a computer.



- To configure FTP server settings, click [Application Settings] and then [FTP Print Settings] in the Web page menu, and configure the settings in "FTP Print Settings from Operation Panel". (Administrator rights are required.)

1

DOCUMENT
FILING



Press the [DOCUMENT FILING] key.

2

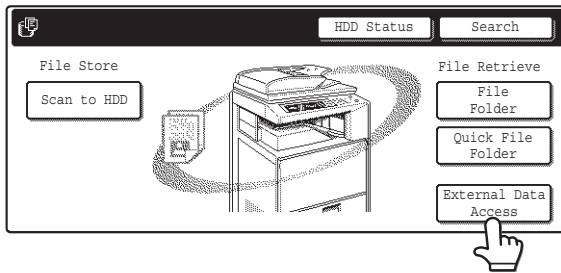

Touch the [External Data Access] key.

The [External Data Access] key cannot be touched if an FTP server is not configured.

3

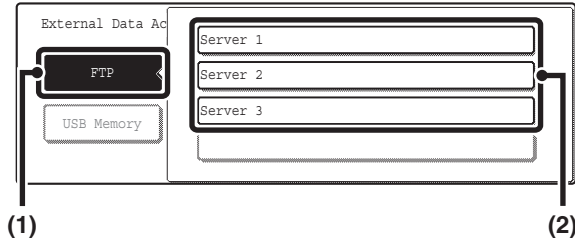



Access the FTP server.

- (1) Touch the [FTP] key.
- (2) Touch the key of the FTP server that you wish to access.

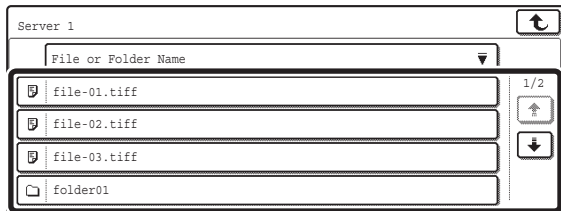

4



Touch the key of the file that you wish to print.

- The icon  appears on the left side of keys of files that can be printed.
- The icon  is displayed on the left side of keys of folders on the FTP server. To display the files and folders in a folder, touch the key of the folder.



- A total of 100 keys of files and folders can be displayed.
- Touch the  key to move up one folder level.
- When you move down a folder level by touching a folder key, the  key appears in the top right corner of the screen. Touch this key to move up to the root folder (the top folder level in the selected FTP server).
- Touch the [File or Folder Name] key (or the [File Name] key) to change the order of the files and folders displayed on the screen. The order switches between ascending order and descending order each time you touch the key.

5

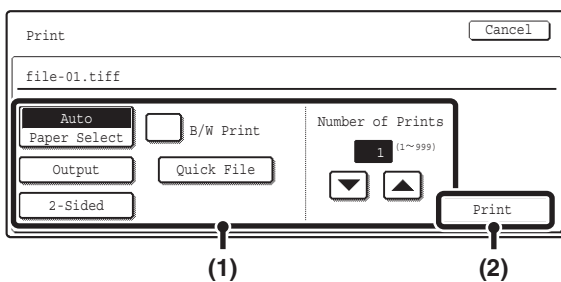

Print the selected file.

- (1) Select print conditions.
If you selected a file (PCL or PS) in step 4 that includes print settings, the settings will be applied.
- (2) Touch the [Print] key.
Printing begins. When the message "Job stored. ..." appears in the touch panel, touch the [OK] key.



When you select a PDF file that has a password, you must enter the password in the job status screen to begin printing.

 [PRINTING AN ENCRYPTED PDF FILE](#) (page 54)

DIRECTLY PRINTING A FILE IN USB MEMORY

A file in a USB memory device connected to the machine can be printed from the operation panel of the machine without using the printer driver. When the printer driver of the machine is not installed on your computer, you can copy a file into a commercially available USB memory device and connect the device to the machine to print the file directly.

1

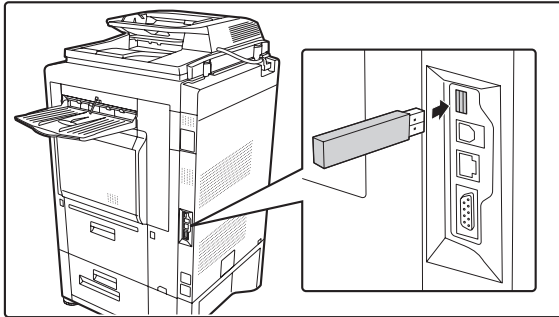

Connect the USB memory device to the machine.



Consult your dealer for USB memory devices that can be used.

2



Press the [DOCUMENT FILING] key.

3

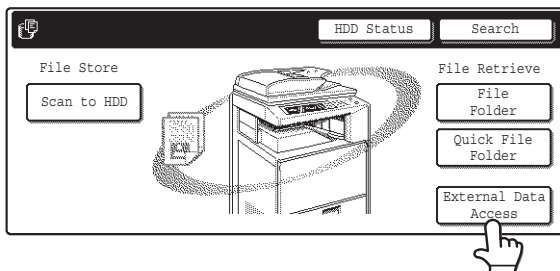

Touch the [External Data Access] key.

If the USB memory device is not connected correctly, the [External Data Access] key cannot be touched.

4

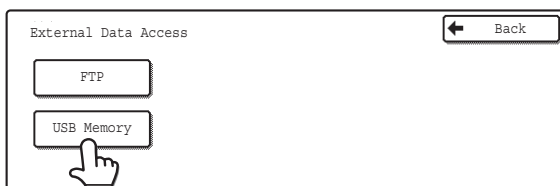

Touch the [USB Memory] key.

5



Touch the key of the file that you wish to print.

A maximum of 100 printable files in the USB memory device can be displayed.



- To return to the screen of step 4, touch the [Back] key.
- Files in a folder in a USB memory device will not appear.
- To change the order of display of the files on the screen, touch the [File Name] key. The order switches between ascending order and descending order each time you touch the key.

6

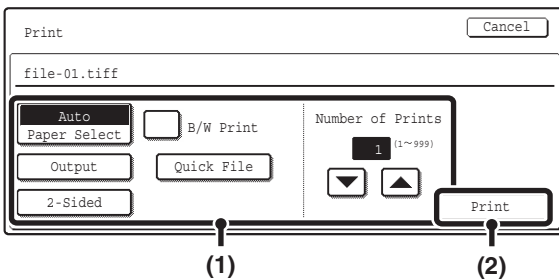

Print the selected file.

(1) Select print conditions.

If you selected a file (PCL or PS) in step 5 that includes print settings, the settings will be applied.

(2) Touch the [Print] key.

Printing begins after the selected file is transferred. When the message "Job stored. ..." appears in the touch panel, touch the [OK] key.



To cancel printing...

To cancel printing while the file is being transferred, touch the [Cancel] key in the message screen that appears in the touch panel.

7

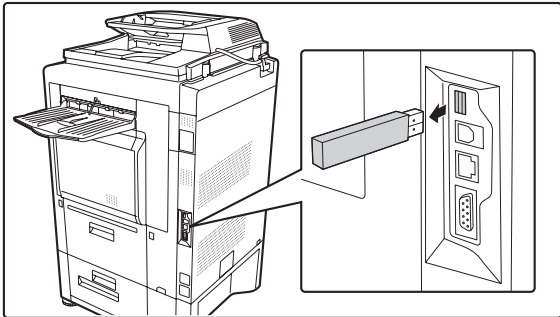

Remove the USB memory device from the machine.



When you select a PDF file that has a password, you must enter the password in the job status screen to begin printing.

[PRINTING AN ENCRYPTED PDF FILE](#) (page 54)

DIRECTLY PRINTING FROM A COMPUTER

Settings can be configured in the Web pages of the machine to enable direct printing from a computer without using the printer driver.

SUBMIT PRINT JOB

You can specify a file to be printed directly without using the printer driver.

In addition to a file on your computer, this procedure can be used to print any file that can be accessed from your computer, such as a file on another computer connected to the same network.

To directly print a file on a computer, click [Document Operations] and then [Submit Print Job] in the Web page menu.

FTP PRINT

You can print a file from your computer by simply dragging and dropping the file onto the FTP server of the machine.

- **Configuring settings**

To enable FTP Print, click [Application Settings] and then [FTP Print Settings] in the Web page menu, enable FTP Print in "FTP Print Settings from Client PC", and configure the port number. (Administrator rights are required.)

- **Performing FTP Print**

Type "ftp://" and then the IP address of the machine in the address bar of your computer's Web browser as shown below.

(Example)

ftp://192.168.1.28

Drag and drop the file that you wish to print onto the "lp" folder that appears in your Web browser. The file will automatically begin printing.



If you printed a file (PCL or PS) that includes print settings, the settings will be applied.

E-MAIL PRINT

An e-mail account can be configured in the machine to have the machine periodically check your mail server and automatically print received e-mail attachments without using the printer driver.

• Configuring settings

To use E-mail Print, you must first configure an e-mail account in the machine. To configure an account, click [Application Settings] and then [E-mail Print Settings] in the Web page menu. (Administrator rights are required.)

• Using E-mail Print

To print a file using E-mail Print, use your e-mail program on your computer to send the file as an attachment to the machine's e-mail address.

Control commands can be entered in the message of the e-mail to specify the number of copies and print format. Commands are entered in the format "command name = value".

The following control commands can be entered:

Function	Command name	Values
Copies	COPIES	1-999
Staple	JOBSTAPLE	STAPLENO, STAPLELEFT, STAPLETWO
Punch	PUNCH	OFF, ON
Output	COLLATE	OFF, ON
Two-sided print	DUPLEX	OFF, TOP, LEFT, RIGHT
Account number*	ACCOUNTNUMBER	Number (5 to 8 digits)
File type	LANGUAGE	PCL, PCLXL, POSTSCRIPT, PDF, TIFF, JPG
Paper	PAPER	Name of available paper (A4, LETTER, etc.)
Document Filing	FILE	OFF, ON
	FOLDERNAME	30 characters
Quick File	QUICKFILE	OFF, ON
Output tray	OUTTRAY	CENTER, RIGHT, FINISHER
Black and white printing	B/W PRINT	OFF, ON

Example

```
COPIES=2
DUPLEX=LEFT
ACCOUNTNUMBER=11111
PAPER=A4
B/W PRINT=ON
```

* Can be omitted except when authentication is by user number.



- Enter the commands in Plain Text format. If entered in Rich Text format (HTML), the commands will have no effect.
- To receive a list of the control commands, enter the command "Config" in the e-mail message.
- If nothing is entered in the body text (message) of the e-mail, printing will take place according to the "Printer Default Settings" in the system settings. If you printed a file (PCL or PS) that includes print settings, the settings will be applied.
- To print PDF and PS files, the PS3 expansion kit must be installed.
- Only enter a "File type" when you are specifying a page-description language. Normally there is no need to enter a file type.

PRINTING AN ENCRYPTED PDF FILE

Encrypted PDF is used to protect a PDF file by requiring the entry of a password to print or edit the file. To directly print an encrypted PDF file on an FTP server or in a USB memory device, follow the steps below to enter the password and begin printing.



The PS3 expansion kit is required to use this function.

1

JOB STATUS

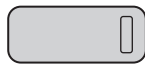

Press the [JOB STATUS] key.

2

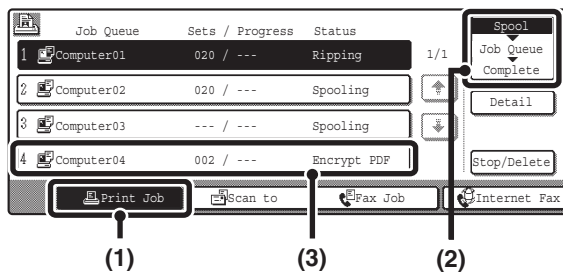

Select the encrypted PDF print job.

(1) Touch the [Print Job] key.

(2) Change the print job status mode to [Spool].

The mode changes each time the key is touched. The currently selected mode is highlighted.

(3) Touch the print job key of the PDF file that has the password.

3

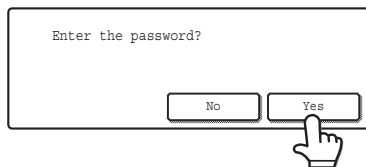

Touch the [Yes] key.

A text entry screen will appear. Enter the password (maximum of 32 characters) and touch the [OK] key. The print job will move to the [Job Queue].



When both a master password and a user password (which is used to open the file) have been set, enter the master password.



- To print an encrypted PDF file using the printer driver, enter the password when opening the file on your computer.
- Printing is not possible if you do not know the password for an encrypted PDF file. To delete a spooled print job, touch the [No] key in the screen of step 3 and touch the [Stop/Delete] key.
- Encrypted PDF versions that can be directly printed are 1.5 (Adobe® Acrobat® 6.0) and earlier.

5

CHANGING THE JOB QUEUE

GIVING A PRINT JOB PRIORITY / CANCELLING A PRINT JOB

GIVING A PRINT JOB PRIORITY

When the machine is busy copying or printing a received fax or other job, you can give priority to a print job that is waiting to be printed and print it ahead of the other jobs.

1

JOB STATUS



Press the [JOB STATUS] key.

2

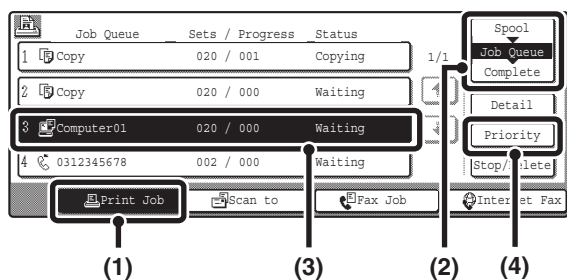

Give the desired job priority.

- (1) Touch the [Print Job] key.
- (2) Change the print job status mode to [Job Queue].

Touch this key to change modes. The selected mode will be highlighted.

- (3) Touch the key of the print job to which you want to give priority.
- (4) Touch the [Priority] key.

The job being printed stops and the job selected in (3) is printed.



To check print information on the selected job, touch the [Detail] key.

CANCELLING A PRINT JOB

A job being printed, a job waiting to be printed, or a spooled job can be cancelled.

1

JOB STATUS



Press the [JOB STATUS] key.

2

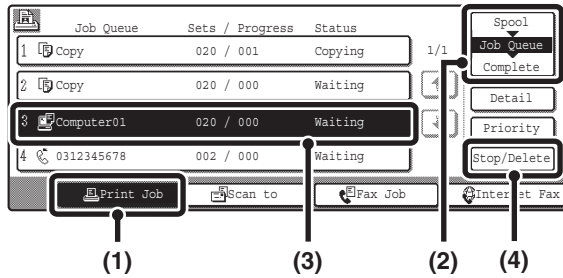

Cancel the job.

- (1) Touch the [Print Job] key.
- (2) Change the print job status mode to [Spool] or [Job Queue].
Touch this key to change modes. The selected mode is highlighted.
- (3) Touch the key of the print job that you wish to cancel.
- (4) Touch the [Stop/Delete] key.
- (5) A message appears to confirm the cancellation. Touch the [Yes] key.
The selected job key is deleted and printing is cancelled.



It is also possible to cancel printing with the [STOP] key (⊘) on the operation panel. When the [STOP] key (⊘) is pressed, a message will appear asking you if you want to cancel the job.



If you do not want to cancel the selected print job...
Touch the [No] key in step 5.

CHANGING TO ANOTHER PAPER SIZE AND PRINTING WHEN PAPER RUNS OUT

If printing stops because the machine ran out of paper, or if the size of paper specified in the printer driver is not loaded in the machine, a message will appear in the touch panel. Printing will begin automatically when the [OK] key is touched and paper is loaded in the machine. If you wish to print on paper in another tray because the desired size of paper is not immediately available, follow the steps below.

1

JOB STATUS



Press the [JOB STATUS] key.

2

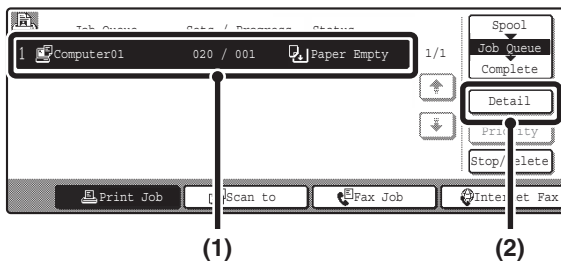

Display details on the print job for which there is no paper.

- (1) Touch the key of the job for which "Paper Empty" appeared.
- (2) Touch the [Detail] key.

3

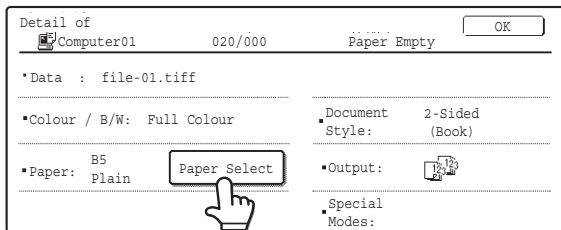

Touch the [Paper Select] key.

4

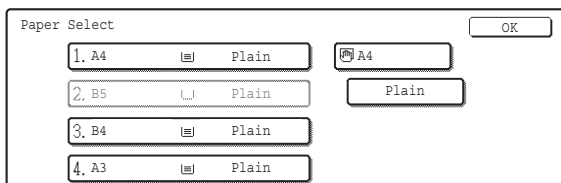

Touch the key of the tray that has the paper you wish to use.

Printing begins.



If you change to another paper size before printing, printing may not take place correctly; for example part of the text or image may run off the paper.

6

PRINTER DRIVER SPECIFICATIONS

PRINTER DRIVER SPECIFICATION LIST

Driver selections		PCL6	PCL5c	SPLC-c ^{*1}	PS	Windows PPD ^{*2}	Macintosh PPD ^{*2}	
Frequently used functions	Copies	1-999	1-999	1-999	1-999	1-999	1-999	
	Orientation	Yes	Yes	Yes	Yes	Yes	Yes	
	N-Up	Printing	2,4,6,8,9,16	2,4,6,8,9,16	2,4,6,8,9,16	2,4,6,8,9,16	2,4,6,9,16 ^{*1,3}	2,4,6,9,16
		Order	Selectable	Selectable	Selectable	Selectable	Selectable	Selectable
		Border	On/Off	On/Off	On/Off	On/Off	Yes	Selectable
	Duplex	Yes	Yes	Yes	Yes	Yes	Yes	
	Fit To Page	Yes	Yes	Yes	Yes	No	Yes ^{*4}	
	Binding Edge	Selectable	Selectable	Selectable	Selectable	No	Yes ^{*5}	
	Black and White Print	Yes	Yes	Yes	Yes	Yes	Yes	
	Staple ^{*6}	Yes	Yes	Yes	Yes	Yes	Yes	
Punch ^{*6}	Yes	Yes	Yes	Yes	Yes	Yes		
Paper	Paper Size	Yes	Yes	Yes	Yes	Yes	Yes	
	Custom Paper	1 size	1 size	1 size	1 size	Yes ^{*1}	Yes ^{*5}	
	Paper Selection	Yes	Yes	Yes	Yes	Yes	Yes	
	Output	Yes	Yes	Yes	Yes	Yes	Yes	
Convenient printer functions	Pamphlet/ Pamphlet Staple ^{*7}	Yes	Yes	Yes	Yes	Yes	Yes	
	Margin Shift	10mm/20mm/ 30mm	10mm/20mm/ 30mm	10mm/20mm/ 30mm	10mm/20mm/ 30mm	Yes	Yes	
	Poster Printing	Yes	No	Yes	Yes	No	No	
	Rotate 180 degrees	Yes	Yes	Yes	Yes	Yes	Yes ^{*5}	
	Zoom/XY-Zoom	Yes ^{*8}	Yes ^{*8}	Yes ^{*8}	Yes	Yes ^{*8}	Yes ^{*8}	
	Mirror Image	No	No	No	Yes	Yes	Yes ^{*9}	

Driver selections		PCL6	PCL5c	SPLC-c*1	PS	Windows PPD*2	Macintosh PPD*2
Special functions	Different Paper	Yes	Yes	Yes*10	Yes	No	Yes*10
	Transparency Inserts	Yes	Yes	Yes	Yes	Yes	Yes
	Carbon Copy	Yes	Yes	No	Yes	No	No
	Tab Printing	Yes	Yes	No	Yes	No	No
	Tandem Print	Yes	Yes	No	Yes	No	Yes*5,11
	Retention	Yes	Yes	Yes	Yes	No	Yes*5
	Document Filing	Yes	Yes	Yes	Yes	No	Yes*5,11
Colour mode adjusting function	Color Adjustment	Yes	Yes	Yes	Yes	No	Yes*5,11,12
	Text To Black/ Vector To Black	Yes	Yes	Yes	Yes	No	No
	Image Type	Yes	Yes	Yes	Yes	Yes	Yes
Functions to combine text and images	Watermark	Yes	Yes	Yes	Yes	Yes	Yes
	Image Stamp	Yes	No	Yes	Yes	No	No
	Overlays	Yes	Yes	No	Yes	No	No
Graphic	Resolution	600x600 dpi/ 300x300 dpi	600x600 dpi/ 300x300 dpi	600x600 dpi/ 300x300 dpi	600x600 dpi/ 1200x600 dpi*13	600x600 dpi	600x600 dpi
	Graphics Mode	Yes	Yes	No	No	No	No
	Toner Save*14	Yes	Yes	No	Yes	Yes	Yes
Font	Resident font	80 fonts	80 fonts	No	136 fonts	136 fonts*15	35 fonts
	Download font	bitmap, TrueType, Graphics	bitmap, TrueType, Graphics	No	bitmap, TrueType, Type1	bitmap, TrueType, Type1	No*16
Others	Auto Configuration	Yes	Yes	Yes	Yes	No	Yes*5,12
	User Authentication	Yes	Yes	Yes	Yes	No	Yes*5

*1 Cannot be used in Windows NT 4.0.

*2 The specifications of each function in Windows PPD and Macintosh PPD vary depending on the operating system version and the software application.

*3 Only 2-Up and 4-Up printing can be used in Windows 98.

*4 Only Mac OS X v10.4 can be used.

*5 Cannot be used in Mac OS X v10.1.5.

*6 Can be used when a finisher or saddle stitch finisher is installed. (To use the punch function, a punch module must be also installed.)

*7 To use the pamphlet staple function, a saddle stitch finisher is required.

*8 The horizontal and vertical proportion cannot be set separately.

*9 Only Mac OS 9.0 to 9.2.2 can be used.

*10 Only covers can be inserted.

*11 Cannot be used in Mac OS 9.0 to 9.2.2.

*12 Cannot be used in Mac OS X v10.2.8.

*13 1200x600 dpi can only be selected for black and white printing.

*14 This setting may not operate in some software applications and operating systems.

*15 The number of available resident fonts is 35 in Windows NT 4.0.

*16 True Type and Type 1 can be selected in some versions of LaserWriter.

Printer Guide

MODEL: MX-2300G MX-3500N
MX-2300N MX-3501N
MX-2700G MX-4500N
MX-2700N MX-4501N



SHARP®