

# SHARP®

MODEL

# AR-203E

DIGITAL MULTIFUNCTIONAL  
SYSTEM

OPERATION MANUAL

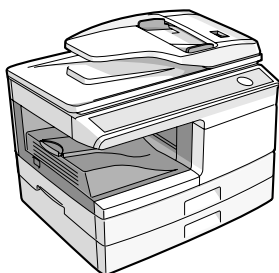

	Page
INTRODUCTION .....	4
LOADING PAPER .....	7
MAKING COPIES .....	12
INSTALLING THE SOFTWARE .....	20
SPECIAL FUNCTIONS .....	42
MAINTENANCE .....	45
TROUBLESHOOTING THE UNIT .....	50
OPTIONS .....	58
APPENDIX .....	61

Shielded interface cables must be used with this equipment to maintain compliance with EMC regulations.

Do not make copies of anything which is prohibited from copying by law. The following items are normally prohibited from copying by national law. Other items may be prohibited by local law.

- Money
- Stamps
- Bonds
- Stocks
- Bank drafts
- Checks
- Passports
- Driver's licenses

In some areas, the "POWER" switch positions are marked "I" and "O" on the copier instead of "ON" and "OFF".

The symbol "O" denotes the copier is not completely de-energized but in a stand-by condition at this "POWER" switch position. If your copier is so marked, please read "I" for "ON" and "O" for "OFF".

**Caution!**

**For a complete electrical disconnection, pull out the main plug.**

**The socket-outlet shall be installed near the equipment and shall be easily accessible.**

# CAUTIONS

## Caution label on the unit

The label (   ) in the fusing area of the unit indicates the following:

 : Caution, risk of danger     : Caution, hot surface

## Cautions on using

Follow the cautions below when using this unit.

### **Warning:**

- The fusing area is hot. Exercise care in this area when removing misfed paper.
- Do not look directly at the light source. Doing so may damage your eyes.
- Do not switch the unit rapidly on and off. After turning the unit off, wait 10 to 15 seconds before turning it back on.
- Unit power must be turned off before installing any supplies.

### **Caution:**

- Place the unit on a firm, level surface.
- Do not install the unit in a humid or dusty location.
- When the unit is not used for a long time, for example for consecutive holidays, turn the power switch off and remove the power cord from the outlet.
- When moving the unit, be sure to turn the power switch off and remove the power cord from the outlet.
- Do not cover the unit with a dust cover, cloth or plastic film while the power is on. Doing so may prevent heat radiation, damaging the unit.
- Use of controls or adjustments or performance of procedures other than those specified herein may result in hazardous radiation exposure.
- The socket-outlet shall be installed near the equipment and shall be easily accessible.

## Important points when selecting an installation site

**Do not install your unit in areas that are:**

- damp, humid, or very dusty
- exposed to direct sunlight
- poorly ventilated
- subject to extreme temperature or humidity changes, e.g., near an air conditioner or heater.

**Be sure to connect the power cord only to a power outlet that meets the specified voltage and current requirements. Also make certain the outlet is properly grounded.**



Note

*Connect the unit to a power outlet which is not used for other electric appliances. If a lighting fixture is connected to the same outlet, the light may flicker.*

**Be sure to allow the required space around the machine for servicing and proper ventilation.**

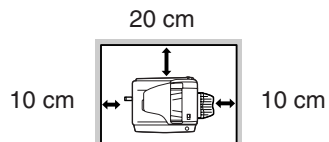

## Cautions on handling

Be careful in handling the unit as follows to maintain the performance of this unit.

**Do not drop the unit, subject it to shock or strike it against any object.**

**Store spare toner cartridges in a cool dry place without removing from the package before use.**

- If they are exposed to direct sunlight or excessive heat, poor copies may result.

**Do not touch the photoconductive drum (green portion).**

- Scratches or smudges on the drum will cause dirty copies.

## Proper storage for supplies

Store the supplies (paper and toner cartridges) in a location that is:

- clean and dry
- at a stable temperature
- not exposed to direct sunlight.

Store paper in the wrapper and lying flat.

- Paper stored out of the wrapper or in packages standing on end may curl or get damp, resulting in paper misfeeds.

## Trademark acknowledgements

- Microsoft and Windows are trademarks of Microsoft Corporation in the U.S.A. and other countries.
- IBM and PC/AT are trademarks of International Business Machines Corporation.
- Adobe and Acrobat are trademarks of Adobe Systems Incorporated.
- All other trademarks and copyrights are the property of their respective owners.



Products that have earned the ENERGY STAR® are designed to protect the environment through superior energy efficiency.

## Laser information

Wave length	780 nm +15 nm -10 nm	(Four laser diodes)
Pulse times	12.88 $\mu$ s $\pm$ 12.88 ns/7 mm	
Output power	Max 0.2 mW (Total Power)	

At the production line, the output power of the scanner unit is adjusted to 0.18 MILLIWATT (Total Power) PLUS 5% and is maintained constant by the operation of the Automatic Power Control (APC).

### Caution

Use of controls or adjustments or performance of procedures other than those specified herein may result in hazardous radiation exposure.

This Digital Equipment is CLASS 1 LASER PRODUCT (IEC 60825-1 Edition 1.2-2001)

A small amount of ozone is produced within the unit during operation. The emission level is insufficient to cause any health hazard.

### Note:

The present recommended long term exposure limit for ozone is 0.1 ppm (0.2 mg/m<sup>3</sup>) calculated as an 8 hr. time-weighted average concentration. However, since the small amount that is emitted may have an objectionable odor, it is advisable to place the unit in a ventilated area.

## SOFTWARE LICENSE

The SOFTWARE LICENSE will appear when you install the software from the CD-ROM. By using all or any portion of the software on the CD-ROM or in the machine, you are agreeing to be bound by the terms of the SOFTWARE LICENSE.

# CONTENTS

## 1 INTRODUCTION

USING THE MANUAL .....	4
PART NAMES .....	5
OPERATION PANEL .....	6

## 2 LOADING PAPER

PAPER .....	7
LOADING THE PAPER TRAY .....	8
BYPASS FEED (including special paper) .....	10

## 3 MAKING COPIES

COPY FLOW .....	12
CONNECTING THE POWER CORD .....	13
ORIGINAL PLACEMENT .....	15
SET THE COPY QUANTITY .....	17
EXPOSURE ADJUSTMENT/ PHOTO COPYING .....	17
REDUCTION/ENLARGEMENT/ ZOOM .....	19

## 4 INSTALLING THE SOFTWARE

SOFTWARE .....	20
BEFORE INSTALLATION .....	21
INSTALLING THE SOFTWARE .....	22
INDICATORS ON THE OPERATION PANEL .....	29
USING THE PRINTER MODE .....	30
USING THE SCANNER MODE .....	32
HOW TO USE THE ONLINE MANUAL .....	41

## 5 DESCRIPTION OF SPECIAL FUNCTIONS

DESCRIPTION OF SPECIAL FUNCTIONS .....	42
TONER SAVE MODE .....	42
USER PROGRAMS .....	43
DISPLAYING TOTAL NUMBER OF COPIES .....	44

## 6 MAINTENANCE

TONER CARTRIDGE REPLACEMENT .....	45
TONER CARTRIDGE LIFE .....	47
CLEANING THE UNIT .....	48

## 7 TROUBLESHOOTING THE UNIT

TROUBLESHOOTING .....	50
STATUS INDICATORS .....	51
MISFEED REMOVAL .....	52
DEVELOPER REQUIRED .....	56
MAINTENANCE REQUIRED .....	56
SCAN HEAD LOCKING SWITCH .....	57

## 8 OPTIONS

SYSTEM CONFIGURATION .....	58
SINGLE PASS FEEDER (AR-SP9) .....	58
IF A PAPER MISFEED OCCURS IN THE MAIN UNIT WHEN USING THE SPF .....	59
250-SHEET PAPER FEED UNIT (AR-D33) .....	60

## 9 APPENDIX

SPECIFICATIONS .....	61
ABOUT SUPPLIES AND OPTIONS .....	64
INDEX .....	65

1

2

3

4

5

6

7

8

9

This chapter provides basic information for using the unit.

## USING THE MANUAL

The operation manual contains explanations of how to operate the unit, important considerations, and maintenance procedures. To get the most out of the unit, please read the operation manual. Please keep the operation manuals in a suitable location that will allow for convenient future reference.

### Conventions used in the manual

This operation manual explains the operation of the AR-203 model.

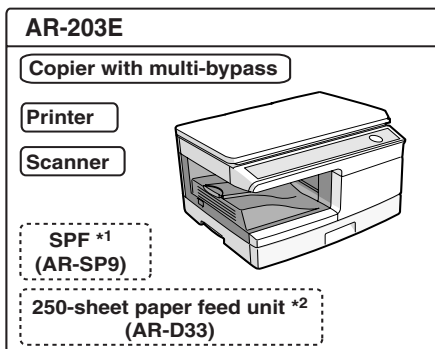

 :Standard functions and equipment

 :Optional functions and equipment

\*1 The optional single pass feeder (AR-SP9) can be installed.

\*2 The optional 250-sheet paper feed unit (AR-D33) can be installed.

- Wherever "AR-xxxx" appears in this manual, please substitute your model name for "xxxx".
- Illustrations of driver screens and other computer screens show the screens that appear in Windows XP Home Edition. Some of the names that appear in these illustrations may differ slightly from the screens that appear in other operating systems.
- This operation manual refers to the Single Pass Feeder as the "SPF".
- In this manual, the following icons are used to provide the user with information pertinent to the use of the unit.



Warns the user that injury may result if the contents of the warning are not properly followed.



Cautions the user that damage to the unit or one of its components may result if the contents of the caution are not properly followed.



Notes provide information relevant to the unit regarding specifications, functions, performance, operation and such, that may be useful to the user.



Indicates a letter displayed in the display.

# PART NAMES

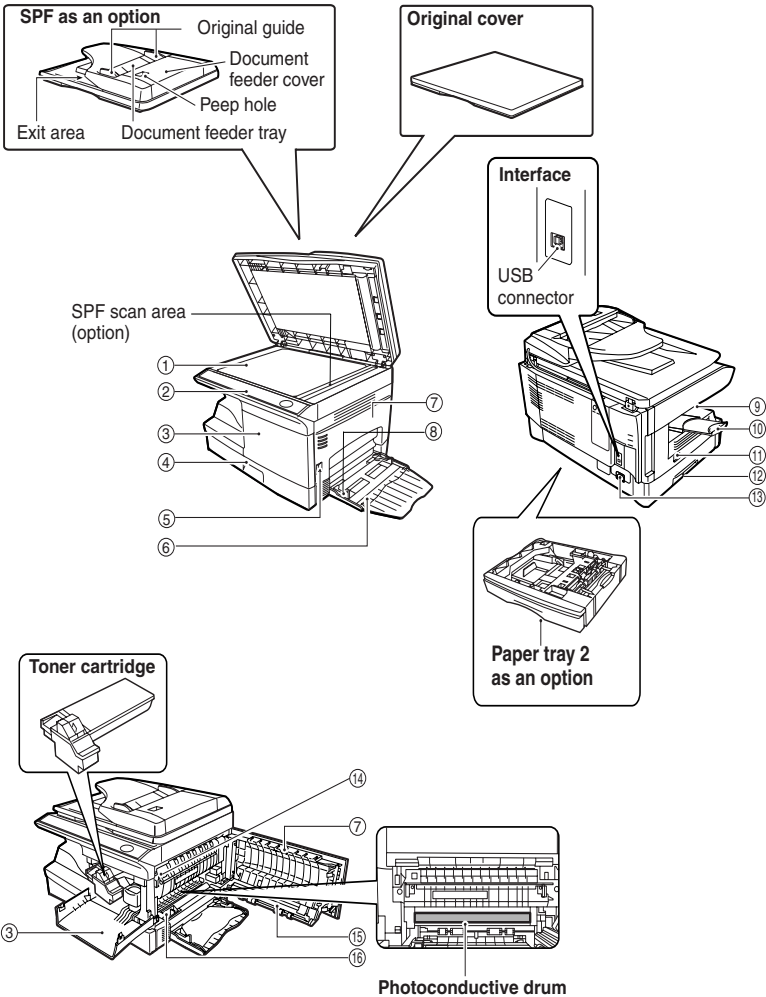

- ① Original table
- ② Operation panel
- ③ Front cover
- ④ Paper tray
- ⑤ Side cover open button
- ⑥ Multi-bypass tray
- ⑦ Side cover
- ⑧ Bypass paper guides
- ⑨ Paper output tray
- ⑩ Paper output tray extension
- ⑪ Power switch
- ⑫ Handle
- ⑬ Power cord socket
- ⑭ Fusing unit release lever
- ⑮ Transfer charger
- ⑯ Charger cleaner

# OPERATION PANEL

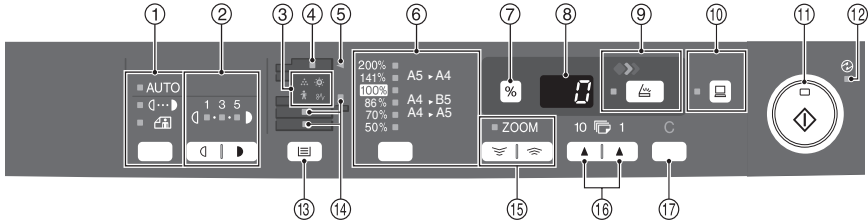

## ① Exposure mode selector key and indicators

Use to sequentially select the exposure modes: AUTO, MANUAL or PHOTO. Selected mode is shown by a lit indicator. (p.17)

## ② Light and dark keys and indicators

Use to adjust the MANUAL or PHOTO exposure level. Selected exposure level is shown by a lit indicator. (p.17) Use to start and terminate user program setting. (p.43)

## ③ Alarm indicators

☼ Developer replacement required indicator (p.56)

⚡ Misfeed indicator (p.52)

⋯ Toner cartridge replacement required indicator (p.45)

✂ Maintenance indicator (p.45)

## ④ SPF indicator (p.16)

Can be used only when your unit has the SPF.

## ⑤ SPF misfeed indicator (p.55)

Can be used only when your unit has the SPF.

## ⑥ Copy ratio selector key and indicators

Use to sequentially select preset reduction/enlargement copy ratios. Selected copy ratio is shown by a lit indicator. (p.19)

## ⑦ Copy ratio display (%) key (p.19)

## ⑧ Display

Displays the specified copy quantity, zoom copy ratio, user program code, and error code.

## ⑨ SCAN key and indicator (p.29, p.37)

## ⑩ ONLINE key and indicator (p.29)

Lights up when the unit is used as a printer and scanner. For description of the ONLINE indicator, see "INDICATORS ON THE OPERATION PANEL" (p.29).

## ⑪ Start key and indicator

- Copying is possible when the indicator is on.
- Press to start copying.
- Use to set a user program. (p.43)

## ⑫ Power save indicator

Lights up when the unit is in a power save mode. (p.42, p.43)

## ⑬ Tray select key

Use to select a paper feed station (paper tray 1, paper tray 2 or multi-bypass tray) (p.19)

## ⑭ Paper feed location indicators

Light up to show the selected paper feed station.

## ⑮ ZOOM keys and indicator

Use to select any reduction or enlargement copy ratio from 25% to 400% in 1% increments. (When the SPF is being used, the zoom copy ratio range is 50% to 200%.) (p.19)

## ⑯ Copy quantity keys

- Use to select the desired copy quantity (1 to 99). (p.17)
- Use to make user program entries. (p.43)

## ⑰ Clear key

- Press to clear the display, or press during a copy run to terminate copying. (p.17)
- Press and hold down during standby to display the total number of copies made to date. (p.44)



Follow the steps below to load paper into the tray.

## PAPER

For best results, use only paper recommended by SHARP.

Type of paper feeding	Type of media		Size	Weight
Paper tray	Standard paper		A4 A5 B5 Letter Legal Invoice	56g/m <sup>2</sup> to 80g/m <sup>2</sup>
Multi-bypass tray	Standard paper and thick paper		A4 A5 A6 B5 B6 Letter** Legal Invoice	56g/m <sup>2</sup> to 128g/m <sup>2**</sup>
	Special media	Transparency film	A4 Letter	
		Envelope*	International DL International C5 Commercial 10 Monarch	

\* Do not use non-standard envelopes, and envelopes that have metal clasps, plastic snappers, string closures, windows, linings, self-adhesive, patches or synthetic materials. Do not use envelopes that are filled with air or envelopes that have labels or stamps attached. These will cause physical damage to the unit.

\*\* For paper weighing from 105g/m<sup>2</sup> to 128g/m<sup>2</sup>, A4 is the maximum size that can be fed through the multi-bypass tray.

- Special papers such as transparency film, labels and envelope must be fed one sheet at a time through the multi-bypass tray.

# LOADING THE PAPER TRAY

- 1** Raise the handle of the paper tray and pull the paper tray out until it stops.

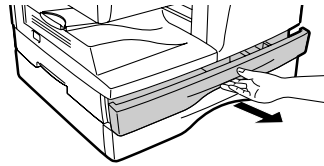

- 2** Adjust the paper guides on the paper tray to the copy paper width and length. Squeeze the lever of paper guide (A) and slide the guide to match with the width of the paper. Move paper guide (B) to the appropriate slot as marked on the tray.

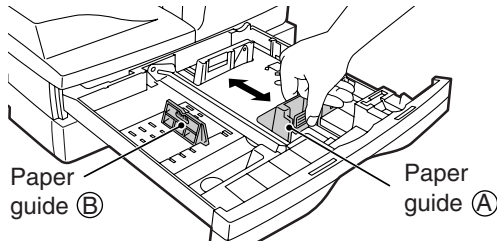

- 3** Fan the paper and insert it into the tray. Make sure the edges go under the corner hooks.



Note

*Do not load paper above the maximum height line (  ). Exceeding the line will cause a paper misfeed.*

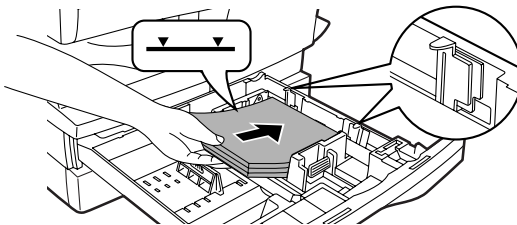



Note

- After loading paper, to cancel the blinking **P** without restarting copying, press the clear (C) key. The **P** in the display will go out and the start (S) indicator will light up.
- Be sure that paper is free of rips, dust, wrinkles, and curled or bent edges.
- Make sure all the paper in the stack is the same size and type.
- When loading paper, ensure there is no space between the paper and the guide, and check if the guide is not set too narrow causing the paper to bend. Loading paper in these ways will result in document skew or a paper jam.
- When not using the unit for an extended period, remove all paper from the paper tray and store it in a dry place. If paper is left in the unit for an extended period, the paper will absorb moisture from the air, resulting in paper jams.
- When adding new paper to the paper tray, remove the old paper already contained in the tray. Placing new paper on top of the paper already contained in the tray may result in feeding two sheets at one time.
- If output paper curls, it may help to turn the paper over when loading it in the tray.

# BYPASS FEED (including special paper)

The multi-bypass tray can be used to feed standard paper, transparency film, labels, envelopes, and other special purpose paper. Paper measuring from A6 to A4 and in the weight range of 56 to 128g/m<sup>2</sup> can be used in this tray. (For paper weighing from 105 to 128g/m<sup>2</sup>, A4 is the maximum size.)



Note

- The multi-bypass tray can hold maximum of 50 sheets of paper. (Capacity will vary depending on the type of paper loaded.)
- The original image must be smaller than the paper or media for copying. If the original image is bigger than the paper or media, this may cause smudges on the edges of the copies.

## The multi-bypass tray

### 1 Open the multi-bypass tray and extend the tray.

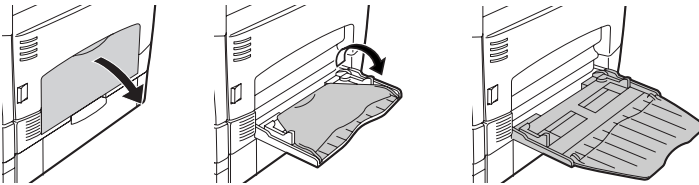

Note

To close the multi-bypass tray, perform step 1 and then step 2 in the illustration and push the round projections at the right of the tray until they click.

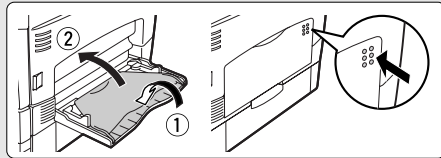

### 2 Set the paper guides to the paper width. Insert the paper (print face down) all the way into the multi-bypass tray.

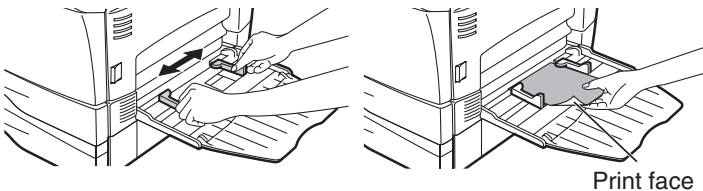

Print face



Note

- *Paper must be fed narrow side into the feed slot.*
- *Transparency film, labels, envelopes, and other special purpose papers must be fed individually.*
- *When copying onto transparency film, remove each copy promptly. Do not let copies stack up. When loading an envelope, make sure that it is straight and flat.*

### **3 Press the tray select (⊖) key to select the multi-bypass tray.**

**2**

#### **Note for loading envelopes**

- Envelopes must be fed narrow side into the feed slot one at a time.
- Do not use non-standard envelopes, and envelopes that have metal clasps, plastic snappers, string closures, windows, linings, self-adhesive, patches or synthetic materials. Do not use envelopes that are filled with air or envelopes that have labels or stamps attached.
- Envelopes of which the surface is not flat because of embossing may cause the copies/prints to become smudged.
- Under high humidity and temperature conditions the glue flaps on some envelopes may become sticky and be sealed closed when copied/printed.
- Use only envelopes which are flat and crisply folded. Curled or poorly formed envelopes may be poorly copied/printed or may cause misfeeds.
- It is recommended that you perform a test copy before performing the actual copied/printed job.
- Be sure to select either Com 10, DL, C5 or Monarch on the paper size setting of the printer driver. (For detailed information on printer driver, refer to the online manual.)

#### **Note for loading thick paper**

Copying on thick paper requires higher fusing temperature setting. Set the user program 29 to "2 (High)" when using thick paper. (See page 43 and 44.)

# 3

## MAKING COPIES

This chapter explains basic and other copying functions.

The unit is equipped with a one-page memory buffer. This memory allows the unit to scan an original once only and make up to 99 copies. This feature improves workflow, reduces operation noise from the copier, and provides higher reliability by reducing wear and tear on the scanning mechanism.



Note

*If the unit does not function properly during use, or if a function cannot be used, see "TROUBLESHOOTING THE UNIT" (p.50).*

### COPY FLOW

- 1 Make sure that paper has been loaded in the paper tray (p.8) or multi-bypass tray (p.10), and check the paper size (p.7).**

If paper is not loaded, see page 8.

- 2 Turn on the unit (p.13).**

- 3 Place the original.**

If you are using the original table, see "Using the original table" (p.15).

If you are using the SPF, see "Using the SPF" (p.16).

When copying onto paper larger than A4, pull out the paper output tray extension.



- 4 Select the copy settings.**

If you wish to copy using the initial settings (p.14), proceed to the next step.

To set the number of copies, see page 17.

To adjust the resolution and contrast settings, see page 17.

To enlarge or reduce the copy, see page 19.

To change the tray used, see page 19.

- 5 Start copying.**

Press the start (⏻) key.

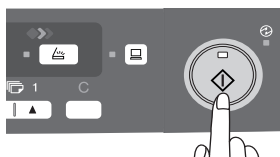

# CONNECTING THE POWER CORD



Warning

*If you use the unit in a country other than the country where the unit was purchased, you will need to make sure that your local power supply is compatible with your model. If you plug the unit into an incompatible power supply, irreparable damage to the unit will result.*

- 1** Ensure that the power switch of the unit is in the OFF position. Insert the attached power cord into the power cord socket at the rear of the unit.

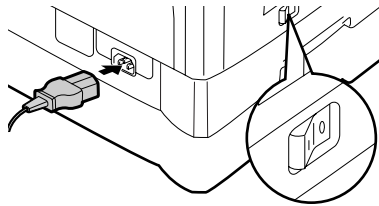

- 2** Plug the other end of the power cord into the nearest outlet.



Caution

*Only insert the power cord into a properly grounded wall socket. Do not use extension cords or power strips.*

## Power on

Ensure that the power switch of the unit is in the OFF position. Plug the other end of the power cord into the nearest outlet. Turn the power switch on the left side of the unit to the "ON" position. The start (Ⓢ) indicator will light up and other indicators which show the initial settings of the operation panel will also light up to indicate the ready condition. For the initial settings, see the "Initial settings of operation panel" described on the next page.

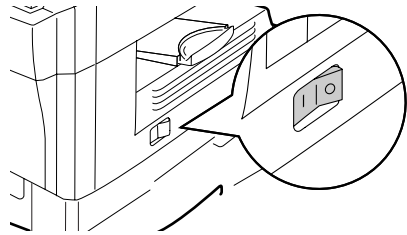

Note

- *The unit will enter a power save mode once the set time has elapsed without any unit operation. The settings of the power save modes can be modified. See "USER PROGRAMS" (p.43).*
- *The unit will return to the initial settings a preset amount of time after the end of copy or scanning job. The preset amount of time (auto clear time) can be changed. See "USER PROGRAMS" (p.43).*

3

## About the scan head

The scan head lamp remains on constantly when the unit is in the ready condition (when the start (⏻) indicator is illuminated).

The unit adjusts the scan head lamp periodically to maintain copying quality. At this time, the scan head moves automatically. This is normal and does not indicate unit trouble.

## Initial settings of operation panel

When the unit power is on, the operation panel will revert to the initial settings when the time set with the "Auto clear time" setting (p.42) elapses after a copy or scanner job is finished, or when the clear (Ⓢ) key is pressed twice.

The initial settings of the operation panel are shown below.

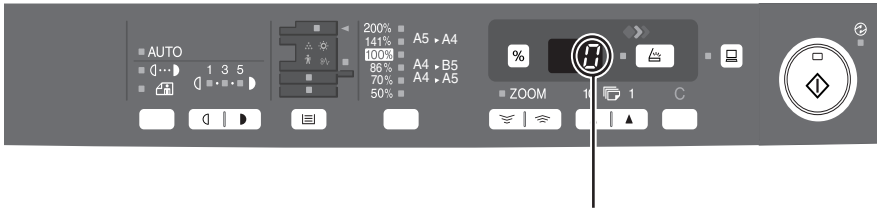

"0" is displayed in the display.

When copying is begun in this state, the settings in the following table are used.

Copy quantity	1 copy
Exposure adjustment	AUTO
Zoom	100%
Tray	Paper tray 1

## Power off methods

If not used for a certain period of time, the unit will automatically enter auto power shut-off mode (p.43) in order to minimise power consumption. In cases where the machine will not be used for a long time, turn off the power switch and remove the power cord from the outlet.

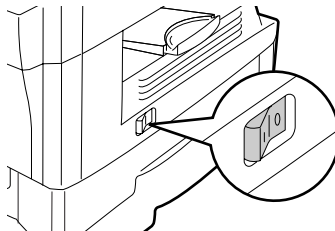



# ORIGINAL PLACEMENT

## Using the original table



Note

- The original table can read up to A4 original.
- Image loss 4mm can occur at the leading and trailing edges of the copies. Also image loss 4.5mm in total can occur along the other edges of the copies.
- When copying a book or an original which has been folded or a crumpled original, press down the original cover lightly. If the original cover is not securely closed, the copies may be striped or blurred.
- When using the document glass to scan an original, make sure that an original is not placed in the SPF.

**1** Open the original cover, and place the original.

**2** Place an original face down on the original table. Align it with the original scale and the centring (▶) mark. Gently close the original cover.

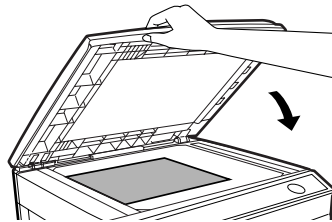
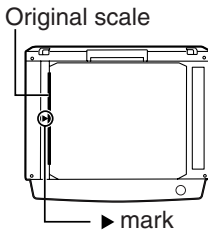

## Setting a large original

The original cover can be removed to allow copying of bulky objects.

**1** Simply lift the original cover straight up.

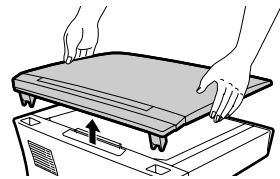

**2** To reattach the original cover, reverse the above procedure.



3

## Using the SPF

The SPF is designed to hold up to 50 originals measuring from A5 to A4 and weighting from 56 to 90 g/m<sup>2</sup>.



Note

- Before feeding originals in the original feeder tray, be sure to remove any staples or paper clips from them.
- Before placing curled or wavy originals into the original feeder tray, be sure to flatten them. If not, original misfeeds may result.
- The SPF (  ) indicator on the operation panel will light up. If this indicator does not light up, the originals are not properly set or the SPF is not properly closed.
- Badly damaged originals may misfeed in the SPF. It is recommended that such originals be copied from the original table.
- Special originals such as transparency film should not be fed through the SPF, but should be placed directly on the original table.
- Image loss (max. 4 mm) can occur at the leading and trailing edges of the copies. Also image loss (max. 4.5 mm in total) can occur along the other edges of the copies.
- To stop continuous copying using the SPF, press the clear (  ) key.

**1** Make sure that no original is left on the original table.

**2** Adjust the original guides to the size of originals.



**3** Set the originals face up in the original feeder tray.

Use the peep hole (see the illustration at right) to check the position of the original. There is an original top edge mark → in the peep hole. Align the top edge of the original with this mark.

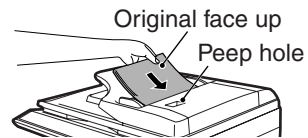

## SET THE COPY QUANTITY

Set the number of copies using the two copy quantity ( $\square\uparrow$ ,  $\square\downarrow$ ) keys when copying from the original table or from the SPF if installed.



Note

- Press the clear ( $\odot$ ) key to clear an entry if a mistake is made.
- A single copy can be made with the initial setting, i.e., when "0" is displayed.

- Press the right copy quantity key to set the unit digit from 0 to 9. This key will not change the tens digit.
- Press the left copy quantity key to set the tens digit from 1 to 9.

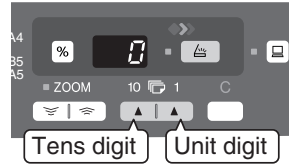

3

## EXPOSURE ADJUSTMENT/PHOTO COPYING

### Exposure adjustment

Copy density adjustment is not required for most originals in the automatic exposure mode. To adjust the copy density manually or to copy photographs, the exposure level can be adjusted in 2 steps manually.



Note

The copy resolution used for AUTO and MANUAL ( $\square\leftarrow\cdots\rightarrow$ ) mode can be changed. (p.43)

1

Press the exposure mode selector key to select the MANUAL ( $\square\leftarrow\cdots\rightarrow$ ) mode or PHOTO ( $\square\uparrow$ ) mode.

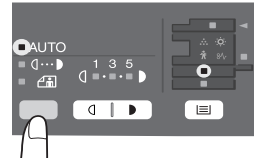

2

Use the light ( $\square\leftarrow$ ) and dark ( $\square\rightarrow$ ) keys to adjust the exposure level. If exposure level 2 is selected, the two left-handmost indicators for that level will light up simultaneously. Also, if level 4 is selected, the two right-handmost indicators for that level will light up simultaneously.

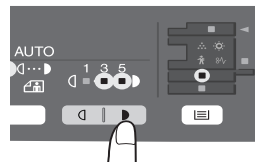

# Automatic exposure adjustment



*This automatic exposure level will remain in effect until you change it again by this procedure.*

The automatic exposure level can be adjusted to suit your copying needs. This level is set for copying from the original table and copying from the SPF respectively.

**1** When adjusting the automatic exposure level for copying from the SPF, place an original in the original feeder tray and make sure that the SPF (☐) indicator lights up. When adjusting the level for copying from the original table, make sure that no original is left in the original feeder tray.

**2** Press the exposure mode selector key to select the PHOTO (📷) mode.

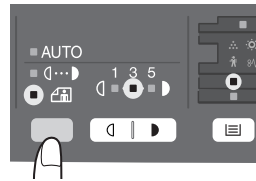

**3** Press and hold down the exposure mode selector key for approximately 5 seconds. The PHOTO (📷) indicator will go out and the AUTO indicator will begin to blink. One or two light and dark indicators corresponding to the automatic exposure level which has been selected will light up.

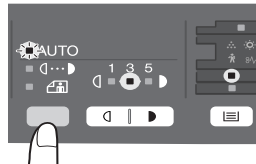

**4** Press the light (☐) or dark (▶) key to lighten or darken the automatic exposure level as desired. If exposure level 2 is selected, the two left-handmost indicators for that level will light up simultaneously. Also, if level 4 is selected, the two right-handmost indicators for that level will light up simultaneously.

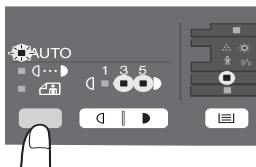

**5** Press the exposure selector key. The AUTO indicator will stop blinking and light up steadily.

# REDUCTION/ENLARGEMENT/ZOOM

Three preset reduction ratios and two enlargement ratios can be selected. The zoom function enables copy ratio selection from 25% to 400% in 1% increments.

## 1 Set the original and check the paper size.

## 2 Use the copy ratio selector key and/or ZOOM ( , ) keys to select the desired copy ratio.





Note

- To verify a zoom setting without changing the zoom ratio, press and hold down the copy ratio display (%) key. When the key is released, the display will return to the copy quantity display.
- To reset the ratio to 100%, press the copy ratio selector key repeatedly until the 100% indicator lights up.

## 3 Set the reduction/enlargement ratio.



Note



To decrease or increase the zoom ratio rapidly, press and hold down the ZOOM (  ) or (  ) key. However the value will stop at the preset reduction or enlargement ratios. To move beyond these ratios, release the key and then press and hold it down again.

### To select a preset copy ratio:

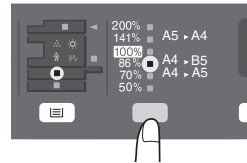
Preset reduction and enlargement ratios are: 50%, 70%, 86%, 141%, and 200%.



### To select a zoom ratio:

When a ZOOM (  or  ) key is pressed, the ZOOM indicator will light up and the zoom ratio will be displayed in the display.

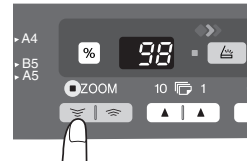

## Selecting the tray

### Press the tray select ( ) key.

Each time you press the tray select (  ) key, the location indicated by the paper feed location indicator changes in the following order: paper tray 1, paper tray 2 if installed, multi-bypass tray.

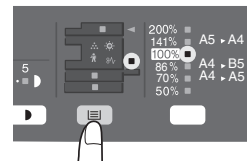

3

# 4

## INSTALLING THE SOFTWARE

This chapter explains how to install and configure the software that is required for the printer and scanner functions of the machine. The procedure for viewing the Online Manual is also explained.



- *The screen images in this manual are mainly for Windows XP. With other versions of Windows, some screen images may be different from those in this manual.*
- *This manual refers to the CD-ROM that accompanied the machine simply as "CD-ROM".*

---

## SOFTWARE

The CD-ROM that accompanies the machine contains the following software:

### MFP driver

#### Printer driver

The printer driver enables you to use the printer function of the machine.

The printer driver includes the Print Status Window. This is a utility that monitors the machine and informs you of the printing status, the name of the document currently being printed, and error messages.

#### Scanner driver\*

The scanner driver allows you to use the scanning function of the machine with TWAIN-compliant and WIA-compliant applications.

### Sharpdesk\*

Sharpdesk is an integrated software environment that makes it easy to manage documents and image files, and launch applications.

### Button Manager\*

Button Manager allows you to use the scanner menus on the machine to scan a document.

\*The scanning feature can only be used with computers that are connected to the machine by a USB cable.

# BEFORE INSTALLATION

## Hardware and software requirements

Check the following hardware and software requirements in order to install the software.

Computer type	IBM PC/AT or compatible computer equipped with a USB 2.0* <sup>1</sup>
Operating system* <sup>2</sup> * <sup>3</sup>	Windows 98, Windows Me, Windows 2000 Professional* <sup>4</sup> , Windows XP* <sup>4</sup> , Windows Vista* <sup>4</sup>
Display	800 x 600 dots (SVGA) display with 256 colors (or better)
Hard disk free space	150 MB or more
Other hardware requirements	An environment on which any of the operating systems listed above can fully operate

\*1 Compatible with Windows 98, Windows Me, Windows 2000 Professional, Windows XP or Windows Vista preinstalled model standardly equipped with a USB port.

\*2 Printing is not available in MS-DOS mode.

\*3 The machine does not support printing from a Macintosh environment.

\*4 Administrator's rights are required to install the software using the installer.

## Installation environment and usable software

The following table shows the drivers and software that can be installed for each version of Windows and interface connection method.

Cable	Operating system	Printer driver	Scanner driver	Button Manager	Sharpdesk
USB	Windows 98/Me/2000/XP/Vista	Available*			Available

\* The printer driver that is installed will vary depending on the type of connection between the machine and your computer.

# INSTALLING THE SOFTWARE



Note

- In the following explanations it is assumed that the mouse is configured for right hand operation.
- The scanner function only works when using a USB cable.
- If an error message appears, follow the instructions on the screen to solve the problem. After the problem is solved, the installation procedure will continue. Depending on the problem, you may have to click the "Cancel" button to exit the installer. In this case, reinstall the software from the beginning after solving the problem.

## Using the machine with a USB connection

**1**

**The USB cable must not be connected to the machine. Make sure that the cable is not connected before proceeding.**

If the cable is connected, a Plug and Play window will appear. If this happens, click the "Cancel" button to close the window and disconnect the cable.



Note

*The cable will be connected in step 13.*

**2**

**Insert the CD-ROM into your computer's CD-ROM drive.**

**3**

**Click the "start" button, click "My Computer" (  ), and then double-click the CD-ROM icon (  ).**

- On Windows Vista, click the "Start" button, click "Computer" and then double-click the CD-ROM icon (  ).
- On Windows 98/Me/2000, double-click "My Computer", and then double-click the CD-ROM icon.

**4**

**Double-click the "setup" icon (  ).**

On Windows Vista, if a message screen appears asking you for confirmation, click "Allow".

**5**

**The "SOFTWARE LICENSE" window will appear. Make sure that you understand the contents of the software license, and then click the "Yes" button.**



Note

*You can show the "SOFTWARE LICENSE" in a different language by selecting the desired language from the language menu. To install the software in the selected language, continue the installation with that language selected.*

**6**

**Read the "Readme First" in the "Welcome" window and then click the "Next" button.**



- 7** To install all of the software, click the "Standard" button and go to step 12.  
To install particular packages, click the "Custom" button and go to next step.

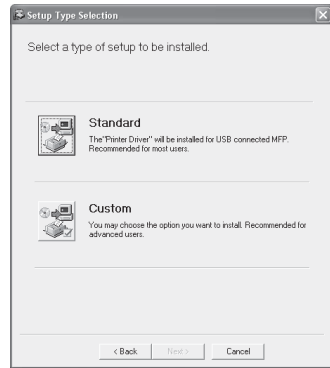

- 8** Click the "MFP Driver" button.

Click the "Display Readme" button to show information on packages that are selected.

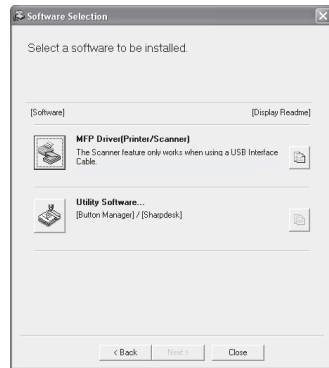

4

- 9** Select "Connected to this computer" and click the "Next" button.

Follow the on-screen instructions.  
When "The installation of the SHARP software is complete." appears, click the "OK" button and go to step 12.

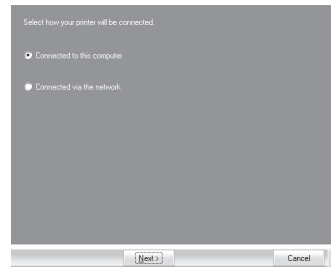

Caution

- If you are using Windows Vista and a security warning window appears, be sure to click "Install this driver software anyway".
- If you are running Windows 2000/XP and a warning message appears regarding the Windows logo test or digital signature, be sure to click "Continue Anyway" or "Yes".

**10** You will return to the window of step 8. If you wish to install **Button Manager** or **Sharpdesk**, click the **"Utility Software"** button. If you do not wish to install the Utility Software, click the **"Close"** button and go to step 12.



*After the installation, a message prompting you to restart your computer may appear. In this case, click the **"Yes"** button to restart your computer.*

## Installing the Utility Software

**11** Click the **"Button Manager"** or the **"Sharpdesk"** button.

Click the **"Display Readme"** button to show information on packages that are selected.  
Follow the on-screen instructions.

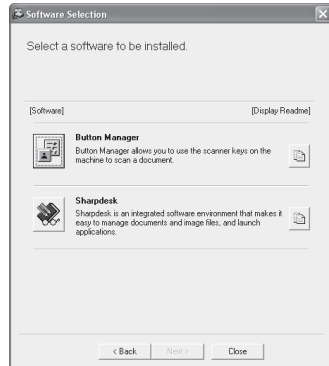

*In Windows 98/Me/2000, if the following screen appears, click the **"Skip"** button or the **"Continue"** button as appropriate to continue the Sharpdesk installation.*

*If **"Skip"** is selected, the Sharpdesk installation will continue without installing Sharpdesk Imaging.  
If **"Continue"** is selected, Sharpdesk Imaging will be installed. If Imaging for Windows is installed on your computer, Sharpdesk Imaging will overwrite Imaging for Windows.*

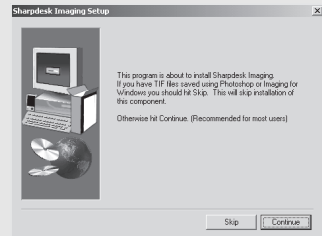

**12** When installing is finished, click the **"Close"** button.



- If you are using Windows Vista and a security warning window appears, be sure to click **"Install this driver software anyway"**.
- If you are running Windows 2000/XP and a warning message appears regarding the Windows logo test or digital signature, be sure to click **"Continue Anyway"** or **"Yes"**.

A message will appear instructing you to connect the machine to your computer. Click the **"OK"** button.



Note

*After the installation, a message prompting you to restart your computer may appear. In this case, click the "Yes" button to restart your computer.*

---

**13** **Make sure that the power of the machine is turned on, and then connect the USB cable (p. 26).**

Windows will detect the machine and a Plug and Play screen will appear.

---

**14** **Follow the instructions in the plug and play window to install the driver.**

Follow the on-screen instructions.



Caution

- *If you are using Windows Vista and a security warning window appears, be sure to click "Install this driver software anyway".*
- *If you are running Windows 2000/XP and a warning message appears regarding the Windows logo test or digital signature, be sure to click "Continue Anyway" or "Yes".*



Note

*A "USB 2.0 Composite Device" installation window may appear prior to this procedure. In this case, follow the instructions in the window to install the USB 2.0 Composite Device.*

4

**This completes the installation of the software.**

- If you installed Button Manager, set up Button Manager as explained in "Setting up the Button Manager" (p.32).
- If you installed Sharpdesk, the Sharpdesk setup screen will appear. Follow the instructions in the screen to set up Sharpdesk.

## Connecting a USB cable

Follow the procedure below to connect the machine to your computer. A USB cable for connecting the machine to your computer is not included with the machine. Please purchase the appropriate cable for your computer.



- *USB is available with a PC/AT compatible computer that was originally equipped with USB and had Windows 98, Windows Me, Windows 2000 Professional, Windows XP Professional or Windows Vista preinstalled.*
- *Do not connect the USB cable before installing the printer driver. The USB cable should be connected during installation of the printer driver.*

### 1 Insert the cable into the USB connector on the machine.

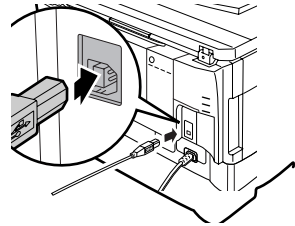

## Using the machine as a shared printer

If the machine will be used as a shared printer on a network, follow these steps to install the printer driver in the client computer.



*To configure the appropriate settings in the print server, see the operation manual or help file of your operating system.*

### 1 Perform steps 2 through 6 in "Using the machine with a USB connection" (p.22).

### 2 Click the "Custom" button.

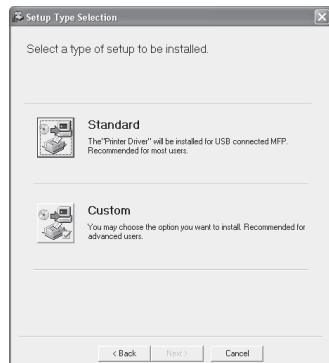

### 3 Click the "Printer Driver" button.

Click the "Display Readme" button to show information on packages that are selected.

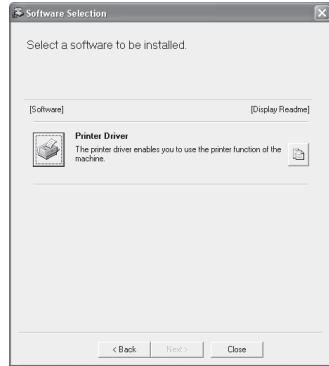

### 4 Select "Connected via the network" and click the "Next" button.

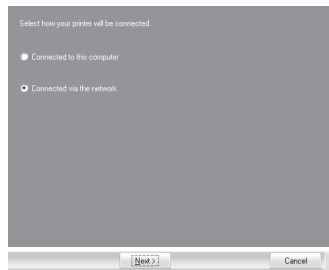

### 5 Click the "Add Network Port" button.

If you are using Windows 98/Me/2000/XP, you can also click the "Add Network Port" button and select the printer to be shared by browsing the network in the window that appears. (On Windows Vista, the "Add Network" Port" button does not appear.)

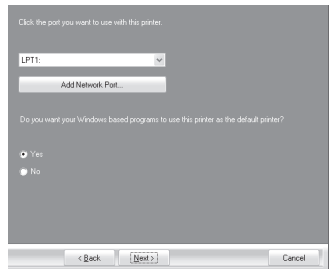

### 6 Select the network printer that is shared and click the "OK" button.

Ask your network administrator for the server name and printer name of the machine on the network.

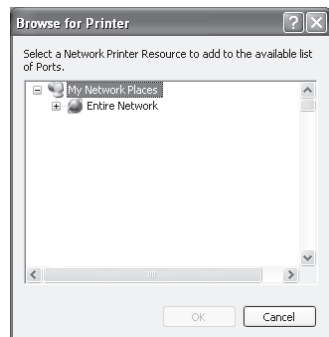

---

**7**

**In the printer port selection window, verify the network printer that is shared and whether the machine is to be used as the default printer, make the selections and click the "Next" button. Follow the on-screen instructions.**



Caution

- *If you are using Windows Vista and a security warning window appears, be sure to click "Install this driver software anyway".*
- *If you are running Windows 2000/XP and a warning message appears regarding the Windows logo test or digital signature, be sure to click "Continue Anyway" or "Yes".*

---

**8**

**You will return to the window of step 3. Click the "Close" button.**



Note

*After the installation, a message prompting you to restart your computer may appear. In this case, click the "Yes" button to restart your computer.*

**This completes the installation of the software.**

# INDICATORS ON THE OPERATION PANEL



To configure the appropriate settings in the print server, see the operation manual or help file of your operating system.

The ONLINE indicator and the start (  ) indicator indicate the state of the printer or scanner.

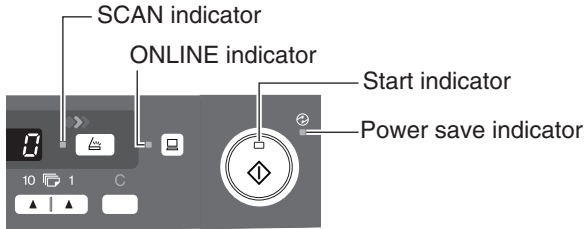

## Start indicator

**On:** Indicates the unit is ready for copying or scanning is being performed.

**Blinking:** The indicator blinks in the following situations:

- When a print job is interrupted.
- When reserving a copy job.
- When toner is being replenished during a copy or print job.

**Off:** The indicator is off in the following situations:

- During copying or scanning.
- The unit is in the auto power shut-off mode.
- When a misfeed or error has occurred.
- During print online.

## ONLINE indicator

The ONLINE key is pressed and on line and off line are changed.

**On:** Indicates the unit is ready for printing or scanning is being performed. (On line)

**Blinking:** Printing or data is being received from a computer.

**Off:** Copying is being performed. (Off line)

## Power save indicator

**On:** Indicates the unit is in a power save mode.

**Blinking:** Indicates that the unit is initialising (when the side cover is opened and closed or the power turned off and on).

## SCAN indicator

**On:** The SCAN (  ) key has been pressed and the unit is in scanner mode.

**Blinking:** A scan job is being executed from the computer, or scan data is stored in the unit's memory.

**Off:** The unit is in the copy mode.

# USING THE PRINTER MODE



*For problems with the printer function, see the online manual or the help file for the driver.*

## Opening the printer driver from the start menu

Open the printer driver setup screen by the method shown below.

---

**1** Click the "start" button.

---

**2** Click "Control Panel", select "Printers and Other Hardware", and then click "Printers and Faxes".

- On Windows Vista, click "Control Panel", and then click "Printer".
- On Windows 98/Me/2000, select "Settings" and click "Printers".

---

**3** Click the "SHARP AR-xxxx" printer driver icon and from the "File" menu select "Properties".

On Windows Vista, select "Properties" from the "Organize" menu.

---

**5** Click "Printing Preferences" button in the "General" tab.

On Windows 98/Me, click the "Setup" tab.  
The printer driver setup screen will appear.



*Refer to the Windows manual or help file for more information on the "General" tab, "Details" tab, "Color Management" tab and "Sharing" tab.*



## How to print

### 1 Make sure that the paper of the desired size and type is loaded in the tray.

The procedure for loading paper is the same as for loading copy paper. See "LOADING PAPER" (p.7).

### 2 Open the document you intend to print, and select "Print" from the application's "File" menu.

### 3 Make sure that "SHARP AR-xxxx" is selected as the current printer. If you intend to change any print setting, click the "Preferences" button to open the setting dialog.

On Windows 98/Me, click the "Properties" button.

On Windows 2000, the "Properties" button does not appear. Set your preferences by switching the tab in the "Print" dialog box.

### 4 Specify the print settings including the number of copies, media type, and print quality, and then click the "Print" button to start printing.

On Windows 98/Me, click the "OK" button to start printing.

For details on print settings, see the online manual or the help file for the printer driver.



Note

- *If copying is being performed when printing is started, copying will continue. After copying is complete, printing will be executed when the clear key is pressed twice, the ONLINE key is pressed to switch the unit to the online state or approximately 60 seconds (auto clear time)\* elapse.*
  - \* *The auto clear time varies with a user program setting. See "USER PROGRAMS" (p.43).*
- *Preheat mode and auto power shut-off mode will be canceled when printing is started.*
- *If the paper size specified from the software application is larger than the paper size in the printer, part of the image that is not transferred to the paper may remain on the surface of the drum. In this case, the backside of the paper may become dirty. If this occurs, change to the correct size paper and print two or three pages to clean the image.*
- *If you start a print job while a scan job is in progress, the print data will be stored in the unit's memory. When the scan job or copy job is completed, printing will begin.*

## About interrupt copying

If you press the start (⏻) key to begin a copy job while a print job using the paper tray is in progress, the copy job will begin automatically after the print data in the unit's memory is printed (interrupt copying). When this is done, the print data remaining in the computer is not sent to the unit. When the copy job ends, press the clear (⏻) key twice, or press the ONLINE key once to change the unit to the online state (p.29), or wait until the set auto clear time (p.42) elapses. The remaining print data will be sent to the unit and printing will resume.

# USING THE SCANNER MODE

Button Manager is a software program that works with the scanner driver to enable scanning from the machine. To scan using the machine, Button Manager must be linked with the scan menu on the machine.

Follow the steps below to link Button Manager to scanner events.



Note

*For problems with the scanner function, see the online manual or the help file for the driver.*

## Using the Button Manager

### Setting up the Button Manager

#### Windows XP/Vista

- 1 Click the "start" button, select "Control Panel" and click "Printers and Other Hardware", and then click "Scanners and Cameras" in the start menu. Right click the "SHARP AR-xxxx" icon and click "Properties" in the menu that appears.**

On Windows Vista, click the "start" button, select "Control Panel" and click "Hardware and sound", and then click "Scanners and Cameras".

- 2 In the "Properties" screen, click the "Events" tab.**



- 3 Click the "Select an event" button and select "ScanMenu SC1" from the pull-down menu. Select "Sharp Button Manager S" in "Start this program" and click "Apply".**

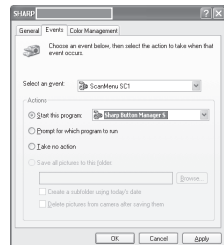

- 4 Repeat step 3 to set "ScanMenu SC2" through "ScanMenu SC6".**

Click the "Select an event" button and select "ScanMenu SC2" from the pull-down menu. Select "Sharp Button Manager S" in "Start this program" and click "Apply". Do the same for each ScanMenu through "ScanMenu SC6". When the settings have been completed, click the "OK" button to close the screen. When the settings have been completed in Windows, start the Button Manager. Adjust detailed settings and then scan an image from the unit. For the procedures for starting Button Manager and adjusting settings, see "Scan Button Destination Setting Dialog Box" (p.34).

## Windows 98/Me/2000

To scan directly into an application using the Button Manager on Windows 98, Windows Me and Windows 2000. Set the Event Manager properties to send only to Button Manager as shown below.

- 1 Click the "Start" button, select "Control Panel" from "Settings", and open "Scanners and Cameras" in start menu.**



Note

*In Windows Me, it occasionally happens that the "Scanners and Cameras" icon does not appear immediately after installation of the MFP driver is completed. If the icon does not appear, click "View all Control Panel options" in the Control Panel and display the "Scanner and Cameras" icon.*

- 2 Select "SHARP AR-xxxx", and click the "Properties" button.**

In Windows Me, right click "SHARP AR-xxxx" and click "Properties" in the menu that appears.

- 3 In the "Properties" screen, click the "Events" tab.**

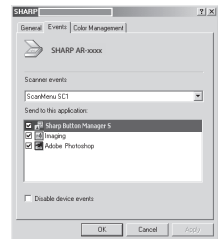

4

- 4 Click the "Scanner events" button and select "ScanMenu SC1" from the pull-down menu. Select "Sharp Button Manager S" in "Send to this application" and click "Apply".**



Note

*If other applications are shown, deselect the checkboxes for the other applications and leave only the Button Manager checkbox selected.*

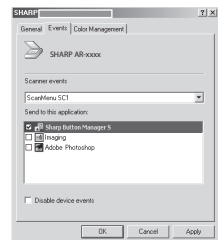

- 5 Repeat step 4 to set "ScanMenu SC2" through "ScanMenu SC6".**

Click the "Scanner events" and select "ScanMenu SC2" from the pull-down menu. Select "Sharp Button Manager S" in "Start this program" and click "Apply". Do the same for each ScanMenu through "ScanMenu SC6". When the settings have been completed, click the "OK" button to close the screen. When the settings have been completed in Windows, start the Button Manager. Adjust detailed settings and then scan an image from the unit. For the procedures for starting Button Manager and adjusting settings, see "Scan Button Destination Setting Dialog Box" (Next page).

## Scan Button Destination Setting Dialog Box

After you have completed the Button Manager settings in Windows, configure the scan settings in Button Manager. To configure the scan settings in Button Manager, right click the (  ) icon in the Taskbar and select "Setting" from the menu that appears.

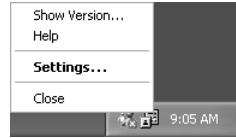

For details on configuring the scan settings in Button Manager, see the online manual or the help file.

This is the corresponding setting in the Button Manager to automatically send multiple images from the SPF at 75 dpi to Sharpdesk using the operation panel "SC1" SCAN (  ) key selection.

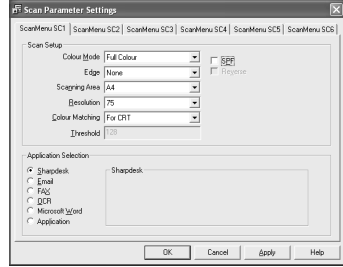

Note

*This dialog shows the SC1 event set to go directly to Button Manager. With the Button Manager set to send the image to Sharpdesk. (factory default setting) Sharpdesk will open after acquiring the image automatically.*

## Flow of the Button Manager setting

The Button Manager can directly handle an AR-xxxx (where xxxx is the model name of your unit) series device event and start your selected application according to the scan setting made on the AR-xxxx (where xxxx is the model name of your unit) operation panel (SC1, SC2, SC3, SC4, SC5, SC6).

This will scan directly into your application from the device.

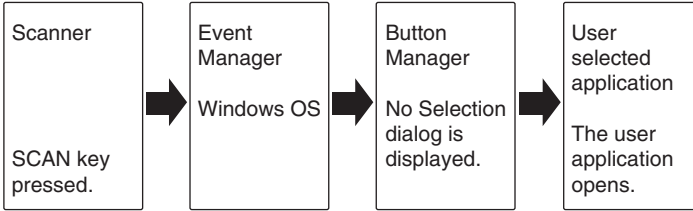

The settings for the Windows Event Manager for the SHARP AR-xxxx (where xxxx is the model name of your unit) device allow the user to take advantage of the Sharp Button Manager to take control of events from Windows and send scanned images to any application that can be selected in Button Manager.

This can be done with the Windows OS showing the Event Manager selection dialog or directly into a selected application if the Button Manager is the only allowed handler for device events from the SHARP AR-xxxx (where xxxx is the model name of your unit).

This is done by changing the Windows device settings for the AR-xxxx (where xxxx is the model name of your unit) in the Scanner and Camera device settings in the Control Panel.

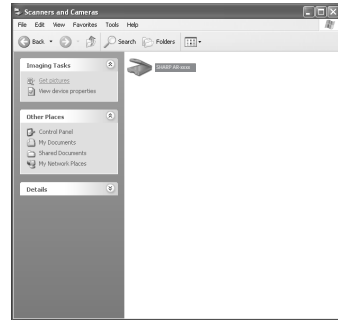

This is the Control Panel Properties dialog for "Scanners and Cameras".

The AR-xxxx is shown selected.

4

# All About The Windows Event Manager and scanner events in Windows 98, Windows Me, Windows 2000, Windows XP and Windows Vista

Windows Platforms provide a mechanism for software to handle external events for a scanner device like the SHARP AR-xxxx (where xxxx is the model name of your unit) series products. This mechanism is controlled by the device manager on a device basis. Applications that can handle events from a scanner/camera device register with the Windows Event Manager and shown as available in the registered applications. The path an event takes to get to the user's selected application depends upon the event settings for the device.

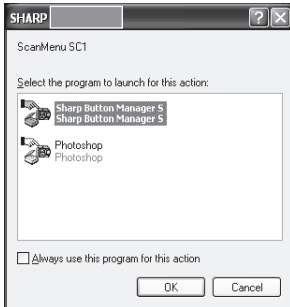
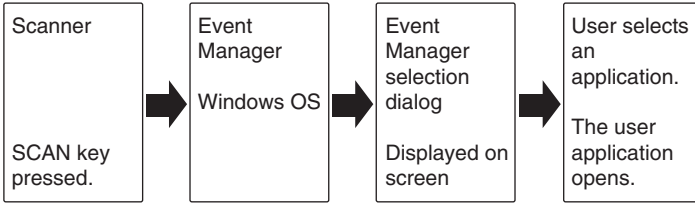

This is the Windows Event Manager Selection Dialog. Shown are two applications registered to handle the scanner event from AR-xxxx (where xxxx is the model name of your unit) device.

## Using the SCAN key to begin scanning



Note

- Scanning is not possible during a copy job.
- If the SCAN (  ) key is pressed during a print job, the scan job will be stored.
- When scanning an original that has been placed in the SPF, only one original can be placed unless you are using Sharpdesk.

### 1 Press the SCAN ( ) key.

The unit enters scan mode.

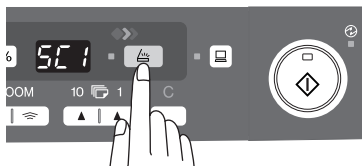

### 2 Place the original you wish to scan on the document glass/SPF.

For the procedure for placing the original, see "ORIGINAL PLACEMENT" (p.15).

### 3 Press the right copy quantity key to display the number of the application that you wish to use for scanning.

The application numbers are initially as follows.

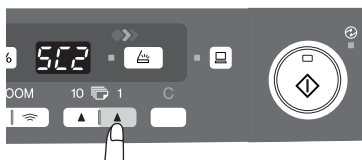

Application number	Application launched
SC1	Sharpdesk
SC2	E-mail
SC3	Fax
SC4	OCR
SC5	Microsoft Word
SC6	Filing

To check the settings, see "Scan Button Destination Setting Dialog Box" (p.34) and then open the settings window of the Button Manager.

4

## 4 Press the start ( ) key.

Scanning will start and the scanned data will be transferred to the application.



Note

- If the following screen appears, select **Button Manager** and click "OK". **Button Manager** starts and the application associated with **Button Manager** starts. If you want only **Button Manager** to start in this case, set up **Button Manager** for use in Windows as explained in "Setting up the **Button Manager**" (p.32).
- If step 4 is performed with the "Show TWAIN setting screen when scanning" checkbox selected in the **Scan Button Destination Setting Dialog Box** (p.34), the TWAIN settings screen (p.39) will automatically appear. Check the settings, and then press the start (  ) key again or click the "Scan" button in the TWAIN setting screen to start scanning. The scanned data will be transferred to the application.

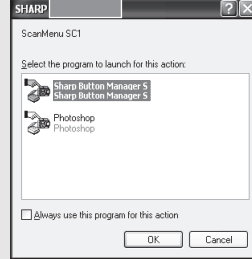

## Opening the scanner driver and scanning from your computer

Follow the steps below to open the scanner driver setup screen. As an example, this instruction is given using Sharpdesk as an image capture application.



Note

- Scanning is not possible during a copy and print job.
- The method for starting the scanner driver differs depending on the type of application. Refer to the manual or the help file of your application.
- When using the scanner driver to scan an original that has been placed in the SPF. If you perform "preview" (see the online manual or the help file for the scanner driver), the original in the SPF will be output to the exit area after previewing. To scan the original after previewing, place the original in the SPF once again.



## Using the SHARP TWAIN

- 1 Place the original(s) you wish to scan on the document glass/SPF.**

For the procedure for placing the original, see "ORIGINAL PLACEMENT" (p.15).

- 2 After starting Sharpdesk, click the "File" menu and select "Select Scanner".**

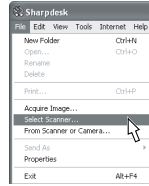

- 3 Select "SHARP MFP TWAIN S", and click the "Select" button.**



Note

*If you use more than one scanning device, select the scanner you want to use through the application. The method for accessing the "Select Scanner" option, depends upon the application. For more information, see the online manual or the help file of your application.*

- 4 Select "Acquire Image" from the "File" menu, or click the "Acquire" button (  ).**

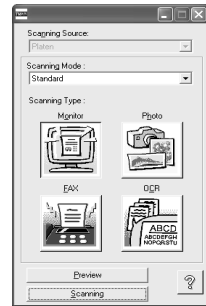

- 5 Set the configuration for scanning (refer to the online manual and help file), and click the "Scan" button.**

Scan is started.

4

## Scanning with the "Scanner and Camera Wizard" in Windows XP

Windows XP includes as a standard feature an image scanning function. The procedure for scanning with the "Scanner and Camera Wizard" is explained here.



Note

To cancel scanning, click the "Cancel" button in the screen that is displayed.

### 1 Place the original you wish to scan on the document glass/SPF.

For the procedure for placing the original, see "ORIGINAL PLACEMENT" (p.15).

### 2 Click the "start" button, select "Control Panel", and click "Printers and Other Hardware", and then click "Scanners and Cameras" in the start menu. Click the "SHARP AR-xxxx" icon and click "Get picture" in "Imaging Tasks".

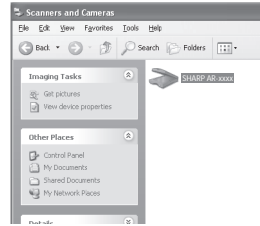

### 3 The "Scanner and Camera Wizard" appears. Click "Next" and establish the basic settings for scanning.

For information on the settings, see the Windows XP help file. After completing each setting, click "Next".

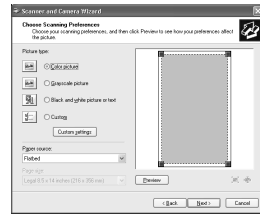

### 4 Select a name, format, and folder for the scanned image.

For information on the image name, file format, and folder, see the Windows XP help file.

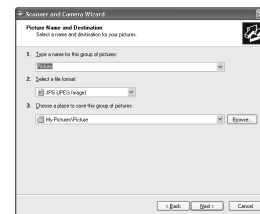

### 5 Scanning begins. When scanning ends, select the next task you wish to perform.

For information on each selection, see the Windows XP help file. To quit the "Scanner and Camera Wizard", select "Nothing. I'm finished working with these pictures." and click "Next".

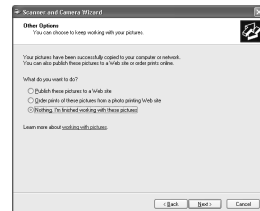

### 6 Click "Finish" in the screen that appears.

The "Scanner and Camera Wizard" closes and the scanned image is saved.

# HOW TO USE THE ONLINE MANUAL

The online manual provides detailed instructions for operating the unit as a printer or scanner and a list of methods for dealing with printing or scanner problems. To access the online manual, your computer must have Acrobat Reader 6.0 or a later version.

**1 Turn on your computer.**

**2 Insert the supplied CD-ROM into your CD-ROM drive.**

**3 Click the "start" button, click "My Computer" (  ), and then double-click the CD-ROM (  ) icon.**

- On Windows Vista, click the "Start" button, click "Computer" and then double-click the CD-ROM icon (  ).
- On Windows 98/Me/2000, double-click "My Computer" (  ), and then double-click the CD-ROM (  ) icon.

**4 Double-click the "Manual" folder, then "AR-203E", double-click the "Online" folder, then double-click the "English" folder, and then double-click the "AR-203E.pdf" icon.**

**5 Click  to read the online manual.**

To close the online manual, click the (  ) button located at the top-right of the window.



Note

- *The online manual can be printed out using Acrobat Reader. SHARP recommends printing out the sections which you refer to frequently.*
- *Refer to "Help" of Acrobat Reader for more details on the operation and function of Acrobat Reader.*

## VIEWING THE ONLINE MANUAL

The "Software CD-ROM" that accompanies the machine contains an online manual in PDF format. To view the manual in PDF format, Acrobat Reader or Adobe Reader of Adobe Systems Incorporated is required. If neither program is installed on your computer, the programs can be downloaded from the following URL:

<http://www.adobe.com/>

This chapter describes the special functions of this unit. Use these functions as needed.

## DESCRIPTION OF SPECIAL FUNCTIONS

### Toner save mode (page 42)

Reduces toner consumption by approximately 10%.

### Power save modes (page 43)

The unit has two power save modes of operation: preheat mode and auto power shut-off mode.

#### Preheat mode

When the unit enters the preheat mode, the power save (☺) indicator will light up and other indicators will remain on or off as before. In this condition, the fuser in the unit is maintained at a lower heat level, thereby saving power. To copy from the preheat mode, make desired copier selections and press the start (⊞) key using the normal copying procedure.

#### Auto power shut-off mode

When the unit enters the auto power shut-off mode, the power save (☺) indicator will light up and other indicators will go out. The auto power shut-off mode saves more power than the preheat mode but requires a longer time before starting copying. To copy from the auto power shut-off mode, press the start (⊞) key. Then make desired copier selections and press the start (⊞) key using the normal copying procedure.

### Auto clear (page 43)

The unit returns to the initial settings a preset amount of time after the end of copy, or scanner job. This preset amount of time (auto clear time) can be changed.

### Resolution of AUTO & MANUAL mode (page 43)

You can set the copy resolution used for AUTO and MANUAL (◁⋯▷) exposure mode.

### Prevention of OC copies when the SPF is up function

When enabled, this function may help prevent wasteful use of toner that occurs when the OC cover is not completely closed.

If the start (⊞) key is pressed when the OC cover is not completely closed, "OP" will appear in the display and copying may not take place. If copying does not take place, copying can be performed by pressing the start (⊞) key again, however, the scan size set in "Copy effective paper width setting function" (program numbers 25, 26, and 27) will be used.

If the OC cover is completely closed after "OP" appears, copying will take place at the normal size.

## TONER SAVE MODE

- 1 Press the exposure mode selector key to select the MANUAL (◁⋯▷) mode.

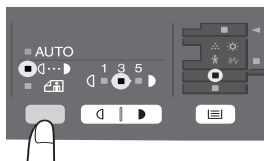

- 2 Press and hold down the exposure mode selector key for approximately 5 seconds. The MANUAL (◁⋯▷) indicator will go out and the PHOTO (📷) indicator will begin to blink. The light and dark indicator marked "5" will light up, indicating the standard toner mode is active.

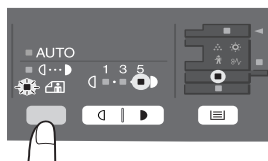

- 3 To enter the toner save mode, press the light () key. The light and dark indicator marked "1" will light up, indicating the toner save mode is selected.

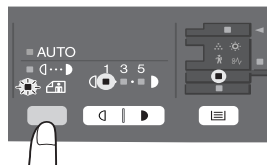

- 4 Press the exposure mode selector key. The PHOTO () indicator will stop blinking and will light up steadily. The light and dark indicator marked "3" will light up. The toner save mode is now active.











*To return to the standard mode, repeat the procedure but use the dark () key to select exposure level "5" in step 3.*

## USER PROGRAMS

The user programs allow the parameters of certain functions to be set, changed, or cancelled as desired.

### Setting the user programs

- 1 Press and hold down the light () key for more than 5 seconds until all the alarm indicators (, , , ) blink and "E--" appears in the display.
- 2 Use the left copy quantity () key to select a user program number. The selected number will blink in the left side of the display.
- 3 Press the start () key. The entered program number will be steadily lit and the currently selected parameter number for the program will blink on the right side of the display.
- 4 Select the desired parameter using the right copy quantity () key. The entered parameter number will blink on the right of the display.

Program No.	Mode	Parameters
1	Auto clear time	1 → 10 sec., 2 → 30 sec., *3 → 60 sec., 4 → 90 sec., 5 → 120 sec., 6 → OFF
2	Preheat mode	*1 → 30 sec., 2 → 60 sec., 3 → 5 min., 4 → 30 min., 5 → 60 min., 6 → 120 min., 7 → 240 min.
3	Auto power shut-off mode	*1 → ON, 2 → OFF
4	Auto power shut-off timer	*1 → 5 min., 2 → 30min., 3 → 60 min., 4 → 120 min., 5 → 240 min.

Program No.	Mode	Parameters
6	SPF automatic original discharge time (if installed)	1 → 5 min., *2 → 30 min., 3 → 60 min., 4 → 120 min., 5 → 240 min., 6 → OFF
10	Resolution of AUTO & MANUAL mode	*1 → 300dpi, 2 → 600dpi
21	Reset factory	1 → YES, *2 → NO
24	Prevention of OC copies when the SPF is up function	*1 → ON, 2 → OFF
25	Copy effective paper width setting function (Bypass tray)	*1 → Large (A4 width), 2 → Small (B5R width)
26	Copy effective paper width setting function (Tray 1)	*1 → Large (A4 width), 2 → Small (B5R width)
27	Copy effective paper width setting function (Tray 2 if installed)	*1 → Large (A4 width), 2 → Small (B5R width)
28	Selection of copy start state (Polygon rotation on/off)	*1 → ON, 2 → OFF
29	Fusing temperature setting when the bypass tray is used	1 → Low, *2 → High

\* Factory default settings are indicated with an asterisk (\*).

## 5 Press the start () key. The right-hand number in the display will be steadily lit and the entered value will be stored.



Note

To change the setting or to set another mode, press the clear () key. The unit will return to step 2.

## 6 Press the light () key to return to the normal copy mode.

# DISPLAYING TOTAL NUMBER OF COPIES

Use the following procedure to display the total number of copies.

**Press and hold down the clear () key for approximately 5 seconds. The total number of copies will appear in two steps, each with three digits.**

**Example: Total number of copies is 1,234.**



# 6

## MAINTENANCE

This chapter describes how to replace the toner cartridge and how to clean unit.



Note

*Be sure to use only genuine SHARP parts and supplies.*



*For best copying results, be sure to use only SHARP Genuine Supplies which are designed, engineered, and tested to maximise the life and performance of SHARP copiers. Look for the Genuine Supplies label on the toner package.*

### TONER CARTRIDGE REPLACEMENT

When the toner cartridge replacement required (⋯) indicator lights up, replacement of the toner cartridge will be needed soon. Obtain a new cartridge. When the toner cartridge replacement required (⋯) indicator blinks, the toner cartridge must be replaced before copying can be resumed. Replace the toner cartridge by following the procedure below.



Note

*During long copy run of a dark original, the start (⊕) indicator may blink, the indicator light up, and the unit stop, even though toner is left. The unit will feed toner up to 2 minutes and then the start (⊕) indicator will light up. Press the start (⊕) key to restart copying.*

#### 1 Open the multi-bypass tray, side cover, and front cover, in that order.

To open the multi-bypass tray, see "The multi-bypass tray" (p.10).

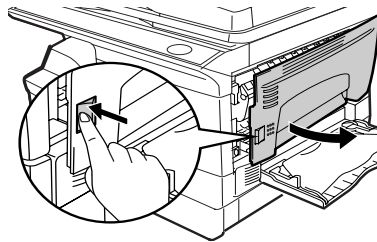

#### 2 Push gently on both sides of the front cover to open the cover.

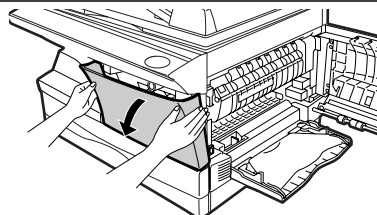

**3 Gently pull the toner cartridge out while pressing the lock release lever.**

Toner cartridge lock release lever

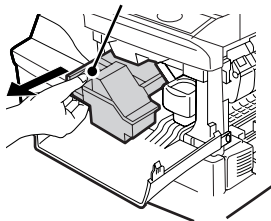

Note

- After removing the toner cartridge, do not shake it or tap on it. Doing so may cause toner to leak from the cartridge. Put the old cartridge immediately in the bag contained in the box of the new cartridge.
- Dispose of the old toner cartridge in accordance with local regulations.

**4 Remove the toner cartridge from the bag. Grasp the cartridge on both sides and shake it horizontally four or five times. After shaking the cartridge, remove the toner seal.**

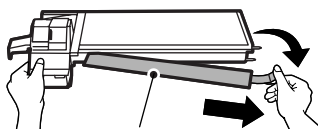
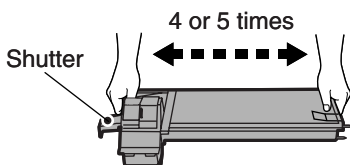

Toner seal





Note

Grasp the toner cartridge as shown in the illustration. Do not hold the cartridge by the shutter. Be sure to only shake the cartridge before the toner seal is removed.

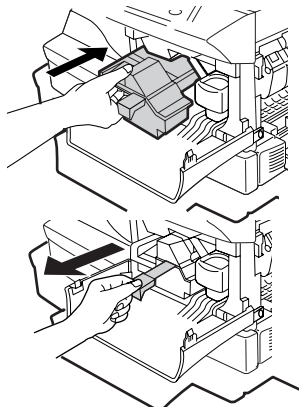
**5 Gently insert the toner cartridge along the guides until it locks in place while pushing the lock release lever. Remove the tape from the shutter. Pull the shutter out of the toner cartridge as shown in the illustration. Discard the shutter.**





- 
- 6** Close the front cover and then the side cover by pressing the round projections near the side cover open button. The indicator (  ) will go out and the start (  ) indicator will light up.



Caution

*When closing the covers, be sure to close the front cover securely and then close the side cover. If the covers are closed in the wrong order, the covers may be damaged.*











Note

*Even after a new toner cartridge is installed, the start (  ) indicator may not light up, indicating copying cannot be restarted (toner is not sufficiently fed). In this case, open and close the side cover. The copier will feed toner again approximately 2 minutes and then copying can be restarted.*

---

## TONER CARTRIDGE LIFE

To find out the approximate quantity of toner remaining, follow the procedure described below.

- 
- 1** Press and hold down the light (  ) key for more than 5 seconds until all the alarm indicators ( , , ,  ) blink and "  " appears in the display.
- 
- 2** Press and hold down the copy ratio display (%) key for more than 5 seconds.  
The approximate quantity of toner remaining will be indicated in the display as a percentage ("100", "75", "50", "25" or "10" is displayed). When the percentage is less than 10%, (  ) will be displayed.
- 
- 3** Press the light (  ) key.  
All alarm indicators will go out.

# CLEANING THE UNIT

Proper care is essential in order to get clean, sharp copies. Be sure to take a few minutes to regularly clean the unit.



*Do not spray flammable cleaner gas. Gas from the spray may come in contact with the internal electrical components or high-temperature parts of the fusing unit, creating a risk of fire or electrical shock.*



- Before cleaning, be sure to turn the power switch off and remove the power cord from the outlet.
- Do not use thinner, benzene or other volatile cleaning agents. Doing so may cause deformation, discoloration, deterioration or malfunction.

## Cabinet

Wipe the cabinet with a soft, clean cloth.

## Original table and the back side of the original cover and SPF (if installed)

Stains on the glass, scanning window, cover or SPF roller will also be copied. Wipe the glass, scanning window, cover or SPF roller with a soft, clean cloth. If necessary, dampen the cloth with a glass cleaner.

Original table/scanning window

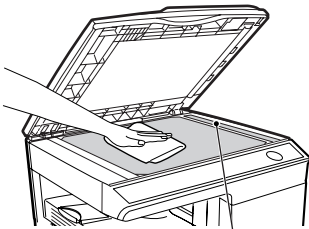

SPF scanning window

Original cover/SPF

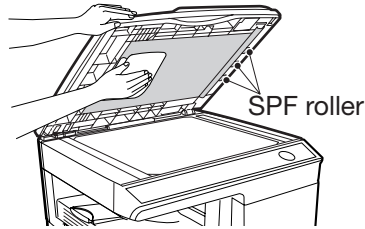

## Transfer charger

If copies start becoming streaky or blotchy, the transfer charger may be dirty. Clean the charger using the following procedure.

**1** Turn the power switch off. (p.14)

**2** Open the multi-bypass, then the side cover while pressing the side cover open button.

**3** Take the charger cleaner out by holding the tab. Set the charger cleaner onto the right end of the transfer charger, gently slide the cleaner to the left end, and then remove it. Repeat this operation two or three times.



Note

*Slide the charger cleaner from the right end to the left end along the groove of the transfer charger. If the cleaner is stopped on the way, smudges on copies may occur.*

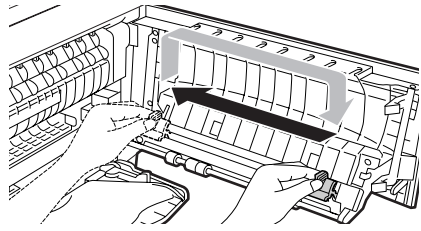
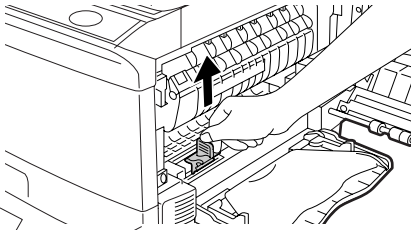

**4** Return the charger cleaner to its original position. Close the side cover by pressing the round projections near the side cover open button.

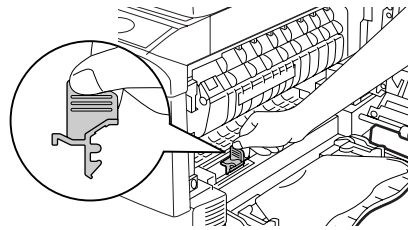

**5** Turn the power switch on. (p.13)

6

This chapter describes misfeed removal and troubleshooting.

## TROUBLESHOOTING

If any problem occurs, check the list below before contacting your authorised service representative.

For problems with the printer function or the scanner function, see the online manual or the Help file for the printer/scanner driver.

Problem	Possible cause	Solution	Page
Unit does not operate.	Unit plugged in?	Plug the unit into a grounded outlet.	13
	Power switch on?	Turn the power switch on.	13
	Side cover closed securely?	Gently close the side cover.	47
	Front cover closed?	Gently close the front cover and then close the side cover.	47
Blank copies	Is the original placed face down on the document glass or face up in the SPF?	Place the original face down on the document glass or face up in the SPF.	15
	Is the scan head locking switch locked?	Unlock the scan head locking switch.	57
Copies are too dark or too light.	Is original image too dark or too light?	Adjust the exposure manually.	17
	Is the unit in the automatic exposure mode?	Adjust the automatic exposure level.	18
	Is the unit in the photo exposure mode?	Cancel the photo exposure mode.	17
Dust, dirt, smudges appear on copies.	Original table or original cover dirty?	Clean regularly.	48
	Original smudged or blotchy?	Use a clean original.	–
Striped copies	Is transfer charger clean?	Clean the transfer charger.	49
Paper misfeeds frequently.	Non-standard paper used?	Use standard paper. If using special papers, feed the paper through the multi-bypass tray.	7
	Paper curled or damp?	Store paper flat in the wrapper in a dry location.	–
	Pieces of paper inside unit?	Remove all pieces of misfed paper.	52
	Paper guides in the paper tray not set properly?	Set the guides properly depending on the paper size.	8
	Too much paper in the paper tray or multi-bypass tray ?	Remove excessive paper from the tray.	8
Images rub off the copy easily.	Is the paper too heavy?	Use paper within the specified range.	7
	The fusing temperature is not appropriate.	In the user programs, set "Fusing temperature setting when the bypass tray is used" (program 29) to "2 (High)".	44
	Paper damp?	Replace with dry paper. If the unit is not used for long time, remove the paper from the paper tray and store it in its wrapper in a dry location.	2
Printing is not uniform between the edges of the paper and the center.	The fusing temperature is not appropriate.	In the user programs, set "Fusing temperature setting when the bypass tray is used" (program 29) to "1 (Low)".	44

# STATUS INDICATORS

When the following indicators light up or blink on the operation panel or the following alphanumeric codes appear in the display, solve the problem immediately referring to both the table below and the relevant page.



*Be sure to use only genuine SHARP parts and supplies.*

Indication			Cause and remedy	Page
	Developer replacement required indicator	Steadily lit	Developer is required. contact your authorised service representative.	56
	Toner cartridge replacement required indicator	Steadily lit	Replacement of Toner cartridge will be needed soon. Prepare a new cartridge. (AR-208T)	45
		Blinking	Toner cartridge must be replaced. Replace it with a new one. (AR-208T)	45
	Misfeed indicator	Blinking	A misfeed has occurred. Remove the misfed paper referring to the description of "MISFEED REMOVAL".	52
			The lower side cover may be open. If so, close it.	55
	Maintenance indicator	Steadily lit	Service by an authorised SHARP service technician is required.	56
	SPF misfeed indicator	Blinking	An original misfeed has occurred in the SPF. Remove the misfed originals referring to the description of "E: Misfeed in the SPF".	55
	Power save indicator is steadily lit.		The unit is in the preheat mode. Press any key to cancel the preheat mode.	42
			The unit is in the auto power shut-off mode. Press the start (⏻) key to cancel the auto power shut-off mode.	42
	The paper tray indicator is blinking.		The paper tray is not installed properly. Push the tray into the unit securely.	-
	"CH" is blinking in the display.		The toner cartridge is not installed. Check if the cartridge is installed. If "CH" is blinking even if a cartridge is installed properly, contact your SHARP service centre immediately.	-
	"CH" is steadily lit in the display.		Side cover is open. Close the side cover securely by pressing the round projections near the side cover open button.	-
	"P" is blinking in the display.		The paper tray or multi-bypass tray is empty. Load paper.	8, 10
			A misfeed has occurred in the paper tray, single bypass or multi-bypass tray. Remove the misfed paper.	52
			Paper tray is not securely installed. Push the tray in securely.	-
	A letter and a number appear alternately.		The scan head locking switch is locked. Unlock the scan head locking switch and turn the power switch off/on.	57
	A letter and a number appear alternately.		The unit will not function. Turn the power switch off and then switch it on, and if there is again an error, remove the power cord from the outlet, and contact your authorized service representative.	-
	A letter and a number appear alternately.		The unit will not function. Turn the power switch off and then switch it on, or when the side cover is opened and then closed ; and if there is again an error, check whether or not you forgot to remove the bundling tape on the cartridge.	-



## MISFEED REMOVAL

When the misfeed (  $\text{8}\wedge\text{v}$  ) indicator blinks or  blinks in the display, the unit will stop because of a misfeed. If a misfeed occurs when using the SPF, a number may appear in the display after a minus sign. This indicates the number of the originals that must be returned to the original feeder tray after a misfeed. Return the required number of originals. Then this number will disappear when copying is resumed or the clear (  $\text{C}$  ) key is pressed. When the SPF misfeeds an original sheet, the unit will stop and the SPF misfeed (  $\text{<}$  ) indicator will blink, while the misfeed (  $\text{8}\wedge\text{v}$  ) indicator will remain off. For a misfeed of originals in the SPF, see "E: Misfeed in the SPF" (p.55).



Note

*If the unit is turned on with the lower side cover open, the misfeed (  $\text{8}\wedge\text{v}$  ) indicator will blink. In this case, close the lower side cover. The misfeed (  $\text{8}\wedge\text{v}$  ) indicator will go out.*

### 1 Open the multi-bypass tray, and side cover, in that order.

To open the multi-bypass tray, see "The multi-bypass tray" (p.10). To open the side cover, see "TONER CARTRIDGE REPLACEMENT" (p.45).

### 2 Check the misfeed location. Remove the misfed paper following the instructions for each location in the illustration below. If the misfeed ( $\text{8}\wedge\text{v}$ ) indicator blinks, proceed to "A: Misfeed in the paper feed area" (p.53).

If the misfed paper is seen from this side, proceed to "C: Misfeed in the transport area". (p.54)

If paper is misfed here, proceed to "B: Misfeed in the fusing area". (p.53)

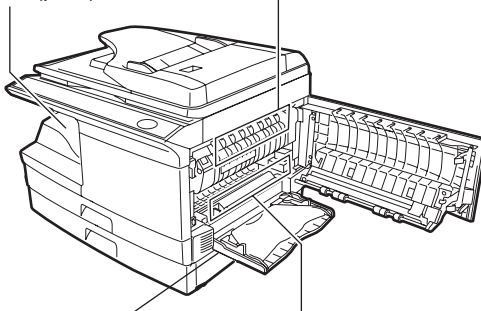

If paper is misfed here, proceed to "D: Misfeed in the lower paper feed area". (p.55)

If paper is misfed here, proceed to "A: Misfeed in the paper feed area". (p.53)

## A: Misfeed in the paper feed area

- 1** Gently remove the misfed paper from the paper feed area as shown in the illustration. When the misfeed (⚠) indicator blinks, and the misfed paper is not seen from the paper feed area, pull out the paper tray and remove the misfed paper. If the paper cannot be removed, proceed to "B: Misfeed in the fusing area".



*The fusing unit is hot. Do not touch the fusing unit when removing misfed paper. Doing so may cause a burn or other injury.*



*Do not touch the photoconductive drum (green portion) when removing the misfed paper. Doing so may cause smudges on copies.*

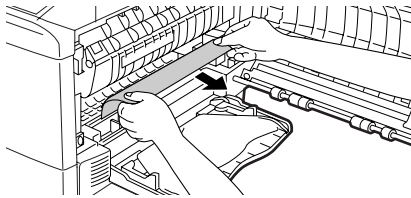

- 2** Close the side cover by pressing the round projections near the side cover open button. The misfeed (⚠) indicator will go out and the start (⏻) indicator will light up.

## B: Misfeed in the fusing area

- 1** Lower the fusing unit release lever.

Fusing unit release lever

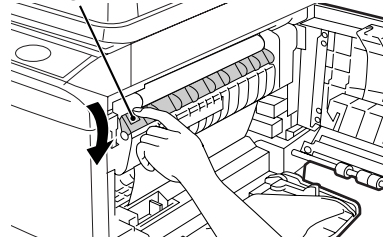

7

- 2** Gently remove the misfed paper from under the fusing unit as shown in the illustration. If the paper cannot be removed, proceed to "C: Misfeed in the transport area".

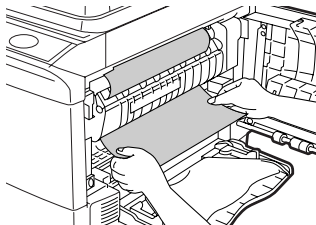

Warning

*The fusing unit is hot. Do not touch the fusing unit when removing misfed paper. Doing so may cause a burn or other injury.*



Caution

- Do not touch the photoconductive drum (green portion) when removing the misfed paper. Doing so may cause smudges on copies.
- Do not remove the misfed paper from above the fusing unit. Unfixed toner on the paper may stain the paper transport area, resulting in smudges on copies.

- 3** Raise the fusing unit release lever and then close the side cover by pressing the round projections near the side cover open button. The misfeed (⊃<sub>v</sub>) indicator will go out and the start (⊕) indicator will light up.

## C: Misfeed in the transport area

- 1** Lower the fusing unit release lever.

See "B: Misfeed in the fusing area" (p.53).

- 2** Open the front cover.

To open the front cover, see "TONER CARTRIDGE REPLACEMENT" (p.45).

- 3** Rotate the feeding roller in the direction of the arrow and gently remove the misfed paper from the exit area.

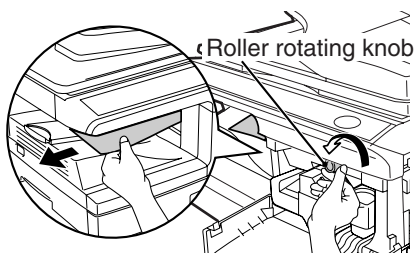



- 4 **Raise the fusing unit release lever, close the front cover and then close the side cover by pressing the round projections near the side cover open button. The misfeed (⌘) indicator will go out and the start (⊕) indicator will light up.**



Caution

*When closing the covers, be sure to close the front cover securely and then close the side cover. If the covers are closed in the wrong order, the covers may be damaged.*

## D: Misfeed in the lower paper feed area

- 1 **Open the lower side cover (under the manual tray) and remove the misfed paper. If  blinks and the misfed paper is not seen from the area of the lower side cover, pull out the lower paper tray and remove the misfed paper. Then close the lower paper tray.**

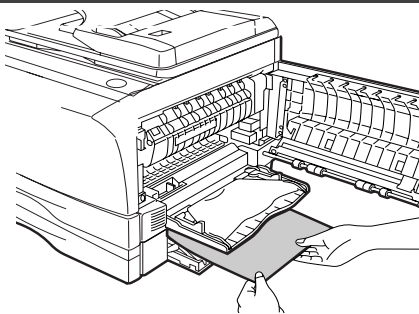

- 2 **Close the lower side cover.**

- 3 **Close the side cover by pressing the round projections near the side cover open button. The misfeed (⌘) indicator will go out and the start (⊕) indicator will light up.**

## E: Misfeed in the SPF

An original misfeed may occur at one of three locations: if the misfed original is seen from the original feeder tray, (A) in the original feeder tray; if the misfed original is not seen from the original feeder tray, (B) in the exit area or (C) under the feeding roller. Remove the misfed original following the instructions for each location.

- (A) **Open the feeding roller cover and pull the original gently to the left and out from the original feeder tray. Close the feeding roller cover. Open and close the original cover to clear the SPF misfeed (◁) indicator. If the misfed original cannot be easily removed, proceed to (C).**

Document feeder cover

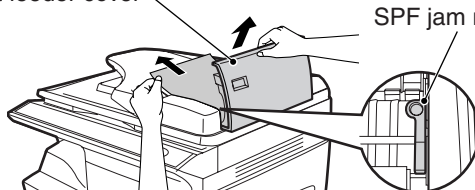

SPF jam release lever

**(B) Open the original cover and rotate the roller rotating knob to remove the misfed original from the exit area. If the misfed original cannot be easily removed, proceed to (C).**



**(C) If the original does not move easily into the exit area, remove it in the direction of the arrow while rotating the knob.**

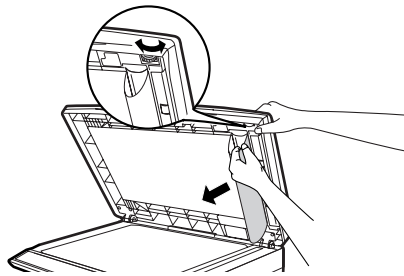

Note

*A number may appear in the display after a minus sign, indicating the number of the originals that must be returned to the original feeder tray. Open and close the SPF to clear the SPF misfeed ( < > ) indicator and then clear the misfeed and return the required number of originals. Then press the start ( ⏻ ) key to resume copying.*



## DEVELOPER REQUIRED

When the developer replacement required ( ⚙ ) indicator lights up, the developer should be replaced. DEVELOPER REPLACEMENT SHOULD ONLY BE DONE BY AN AUTHORIZED SHARP SERVICE TECHNICIAN. Contact your service centre as soon as possible.

## MAINTENANCE REQUIRED

When maintenance ( ⚙ ) indicator lights up, service by an authorised SHARP service technician is required. Contact your service centre as soon as possible.

## SCAN HEAD LOCKING SWITCH

The scan head locking switch is under the original table. If the switch is locked (  ), the unit will not operate. Unlock the switch (  ) as shown below.

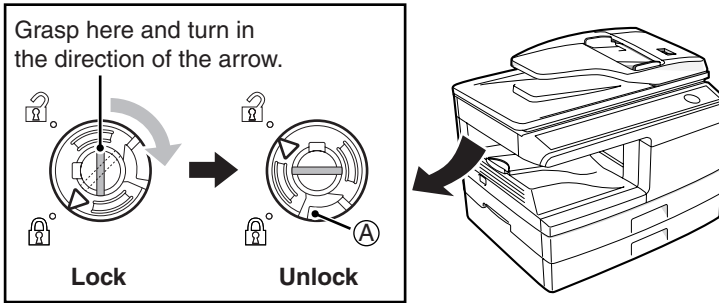

To lock the scan head locking switch, hold up the catch in illustration  and turn the center knob counter-clockwise 90 degrees until you hear a click.

## SYSTEM CONFIGURATION

A number of options are available for the unit which allow you to configure a system to meet your particular needs. The options include the following.

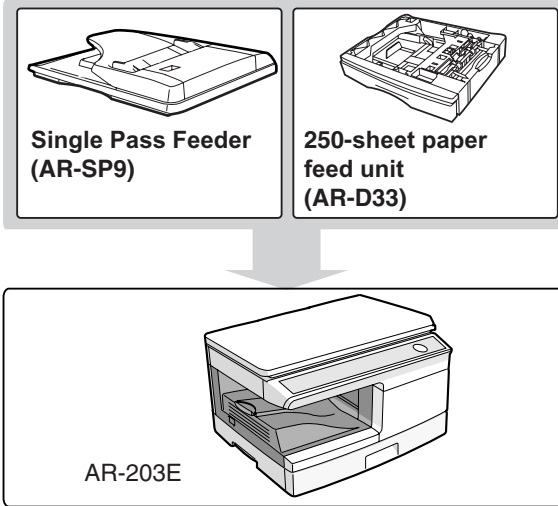

## SINGLE PASS FEEDER (AR-SP9)

The single pass feeder (SPF) holds up to 50 originals for automatic feeding.

The procedures for placing originals in the SPF, cleaning the SPF, and removing a misfeed are explained in the following sections. See "Using the SPF" (p.16), "CLEANING THE UNIT" (p.48) and "E: Misfeed in the SPF" (p.55).

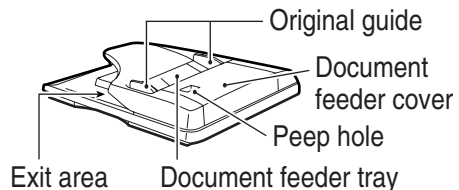

# IF A PAPER MISFEED OCCURS IN THE MAIN UNIT WHEN USING THE SPF

If a paper misfeed occurs in the main unit paper path when making copies with original(s) through the SPF, the SPF will automatically stop scanning. Manually remove the misfed paper(s) in the main unit. You can check the number of originals that must be returned to the document feeder tray in the display on the operation panel. Follow the steps below to display the number of originals to be returned.



Note

*The following procedure omits removal of the misfeed. Be sure to remove the misfeed before displaying the number of originals to be returned. For the misfeed removal procedure, see "MISFEED REMOVAL" (p.52).*

## 1 When a paper misfeed occurs in the main unit, the SPF stops and the ZOOM indicator blinks.

The remaining number of sets will blink in the display. Be sure to remove misfed paper(s) at the main unit paper path first. Then follow the step 2 onwards.

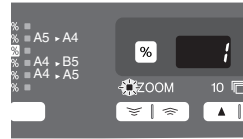

## 2 Remove any originals that have not yet been scanned from the document feeder tray.

For the original(s) stuck in the SPF, do not remove manually. This may cause a machine malfunction. See the step 3.

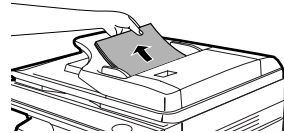

## 3 Press the copy ratio display (%) key.

The originals that were being scanned in the SPF will be discharged and the number of original sheets to be returned will blink in the display. Place the displayed number of original sheets back in the document feeder tray together with the original sheets removed in step 2.

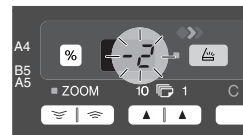
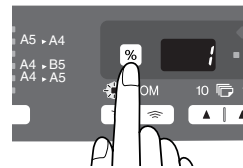

Display of number of original sheets to be returned



Note

*If "SPF automatic original discharge time" is enabled in the user programs, the originals in the SPF will be automatically discharged after the set time elapses. ("USER PROGRAMS" (p.43))*

## 250-SHEET PAPER FEED UNIT (AR-D33)

The paper feed unit provide the convenience of increased paper capacity for the unit and a greater choice of paper size readily available for copying.

The procedures for loading paper in the paper tray of paper feed unit, changing the paper size, and selecting the paper tray are same as for the paper tray in the unit. See "LOADING THE PAPER TRAY" (p.8) and "Selecting the tray" (p.19).

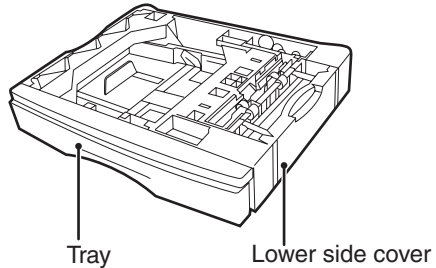

### Using the paper feed unit with the printer function

The AR-D33 can also be used with the printer function. To use the AR-D33 with the printer function, follow these steps to adjust the settings in the printer driver.



Note

*The printer driver cannot be set for use with the AR-D33 when opened from the application.*

**1** Click the "start" button.

**2** Click "Control Panel", select "Printer and Other Hardware", and then click "Printer and Faxes".

- On Windows Vista, select "Settings" and click "Printers".
- On Windows 98/Me/2000, select "Setting" and click "Printers".

**3** Click the "SHARP AR-xxxx" printer driver icon and from the "File" menu select "Properties".

- On Windows Vista, click the "SHARP AR-xxxx" printer driver icon and select "Properties" from the "Organize" menu.
- On Windows 98/Me, click the "SHARP AR-xxxx" printer driver icon, select "Properties" from the "File" menu, and then click the "Setup" tab.

**4** Click the "Utility" tab.

**5** Select "Two trays" for "Input tray option", and click "OK".

The printer driver closes. This completes the settings needed to use the AR-D33.

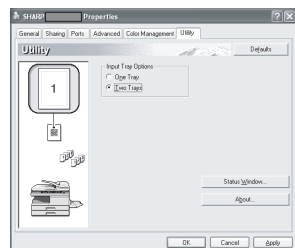

## SPECIFICATIONS

Model		AR-203E
Type		Digital multifunctional system, desk-top type
Copy system		Dry, electrostatic transfer
Originals		Sheets, bound documents
Printer function		Available - Cable required (USB)
Scanner function		Available - Cable required (USB)
Paper tray		250 sheets
Multi-bypass tray		50 sheets
Paper output tray		200 sheets
Original sizes		Max. A4
Original feed	Original table	1 sheet
	SPF	Up to 50 sheets
Copy / printing size		A6 to A4 * <sup>1</sup>
Image loss		Max. 4mm * <sup>2</sup> Max. 4.5mm * <sup>3</sup>
Copy speed		20 pages/min.
Print speed		Max. 15 pages/min. (A4)
Continuous copying		Max. 99 pages subtractive counter
First-copy time (Approximately)		8.0 seconds (When user program 24 is set to OFF) 10.7 seconds (When user program 24 is set to ON) (paper: A4, exposure mode: AUTO, copy ratio: 100%)
Copy ratio		<b>Original table :</b> Variable:25% to 400% in 1% increments (total 376 steps) Fixed: 50%, 70%, 86%, 100%, 141%, 200% <b>SPF:</b> Variable:50% to 200% in 1% increments (total 151 steps) Fixed: 50%, 70%, 86%, 100%, 141%, 200%
Exposure system	Original table	Moving optical source, slit exposure (stationary platen) with automatic exposure
	SPF	Moving original
Fusing system		Heat rollers
Development system		Magnetic brush development
Light source		Cold cathode fluorescent lamp
Resolution	Copier	600 x 300dpi (Auto/Manual mode) 600 x 600dpi (Photo mode)
	Printer	600dpi
	Scanner	600 x 1200dpi
Gradation	Scan	256 levels
	Output	2 levels
Bit depth		1 bit or 8 bit/pixel

Model		AR-203E
Sensor		Colour CCD
Scanning speed		Max. 2.88ms/line
Memory		8 MB
Power supply		Local voltage $\pm 10\%$ (For this copier power supply, see the name plate located on the back of the unit)
Power consumption		1000 W
Overall dimensions	Width	607.6mm
	Depth	462.5mm
Weight (Approximately) *4		16kg
Unit dimensions	Width	518mm
	Depth	462.5mm
	Height	295.6mm
Operating conditions		Temperature: 10°C to 30°C Humidity: 20% to 85%
Emulation		SHARP GDI
Interface port		USB interface (USB 2.0 Full Speed)
Noise level		Sound Power Level L <sub>wA</sub> (1B=10dB) Copying: 6.4 [B] Standby: 3.3 [B] Sound Pressure Level L <sub>pA</sub> (bystander positions) Copying: 48 [dB (A)] Standby: 17 [dB (A)] Sound Pressure Level L <sub>pA</sub> (operator position) Copying: 52 [dB (A)] Standby: 17 [dB (A)] Noise emission measurement in accordance with ISO 7779.
Emission concentration (measurement according to RAL-UZ 62)		Ozone: less than 0.02 mg/m <sup>3</sup> Dust: less than 0.075 mg/m <sup>3</sup> Styrene: less than 0.07 mg/m <sup>3</sup>
Optional equipment		250-sheet paper feed unit (AR-D33) Single Pass Feeder (AR-SP9)

\*1 Feed paper lengthwise only.

\*2 Leading and trailing edges.

\*3 Along the other edges in totals.

\*4 Not including toner and drum cartridges.



## Single pass feeder (AR-SP9)

Acceptable originals	Weight: 56g/m <sup>2</sup> to 90g/m <sup>2</sup> Size: A5 to A4 Capacity: Up to 50 sheets
Power supply	Drawn from the unit.
Weight	Approx. 3kg
Dimensions	498mm (W) x 380mm (D) x 110mm (H)

## 250-sheet paper feed unit (AR-D33)

Paper size	A5 to A4
Paper weight	56g/m <sup>2</sup> to 80g/m <sup>2</sup>
Paper capacity	One paper tray with capacity for 250 sheets of 80g/m <sup>2</sup> bond paper
Weight	3kg
Dimensions	498mm (W) x 395mm (D) x 88mm (H)
Power supply	Drawn from the unit



Note

*As a part of our policy of continuous improvement, SHARP reserves the right to make design and specification changes for product improvement without prior notice. The performance specification figures indicated are nominal values of production units. There may be some deviations from these values in individual units.*

# ABOUT SUPPLIES AND OPTIONS

When ordering supplies, please use the correct part numbers as listed below.



Note

*Be sure to use only genuine SHARP parts and supplies.*



*For best copying results, be sure to use only SHARP Genuine Supplies which are designed, engineered, and tested to maximize the life and performance of SHARP copiers. Look for the Genuine Supplies label on the toner package.*

## Supply list

Supply	Part number	Usable life
Toner cartridge	AR-208T	Approx. 8,000 sheets*

\*Based on copying onto A4-type paper at 6% toned area.

## Interface cable

Please purchase the appropriate cable for your computer.

### USB interface cable

Use a shielded cable.

# INDEX

## 2

250-sheet paper feed unit .....60

## A

About supplies .....64

Alarm indicator

- Developer replacement required indicator.....6, 51, 56
- Maintenance indicator .....6, 51, 56
- Misfeed indicator .....6, 51, 53
- Toner cartridge replacement required indicator.....6, 45, 51

Appendix .....61

Auto clear time .....43

Auto power shut-off mode.....43

Automatic exposure adjustment..... 18

## B

Before installation .....21

Button Manager .....20, 32

Bypass feed .....10

Bypass paper guides .....5, 10

## C

Cautions

- Handling .....1
- Label.....1
- Laser .....2
- Using .....1

Charger cleaner .....5, 49

CLEANING.....48

Cleaning the unit

- Cabinet .....48
- Original cover .....48
- Original table .....48
- SPF .....48
- SPF scanning window .....48
- Transfer charger.....49

Clear key .....6, 17, 44

Connecting a USB interface cable .....26

Conventions used in this manual .....4

Copy flow .....12

Copy quantity .....17

Copy quantity key .....6, 14, 17

Copy ratio display key .....6, 17

Copy ratio selector indicator .....6, 17

Copy ratio selector key .....6, 17

## D

Dark key .....6, 17

Developer replacement required

indicator .....6, 51, 56

Developer required .....56

Display .....6

Displaying total number of copies..... 44

## E

Exposure adjustment..... 17

Exposure mode indicator.....6, 17

Exposure mode selector key .....6, 17

## F

Front cover .....5

Fusing unit release lever .....5, 53

## H

Handle .....5

Hardware and software

requirements.....21

How to print .....31

How to use the online manual .....41

## I

Indicators on the operation panel .....29

Initial settings of operation panel .....14

Installing the software.....22

Interrupt copying.....31

Introduction.....4

## L

Light and dark indicator .....6, 17

Light key .....6, 17

Loading paper.....7

Loading the paper tray.....8

## M

Maintenance indicator .....6, 51, 56

Making copies.....12

MFP driver

- Print Status Window .....20
- Printer driver.....20
- Scanner driver.....20

Misfeed indicator .....6, 51, 53

Misfeed removal

- Fusing area .....53
- Lower paper feed area .....55

- Paper feed area.....	53	SCAN key .....	6, 37
- SPF .....	55	Scanning from your computer .....	38
- Transport area.....	54	Scanning with the "Scanner and	
Multi-bypass tray.....	10	Camera Wizard" .....	40
<b>N</b>		Sharpdesk .....	20
Name		Side cover.....	5
- Operation panel.....	6	Side cover open button.....	5
- Part names .....	5	Software .....	20
<b>O</b>		Specifications .....	61
ONLINE indicator .....	6, 29	SPF.....	16
ONLINE key .....	6, 29	SPF indicator .....	6, 16
Online manual.....	41	SPF misfed indicator .....	6, 52, 55
Opening the printer driver .....	30	Start indicator .....	6, 29
Opening the scanner driver.....	38	Start key .....	6, 12, 44
Operation panel .....	6	Status indicators .....	51
Optional equipment.....	58	System configuration .....	58
Original placement.....	15	<b>T</b>	
- Original table .....	15	Toner cartridge .....	45
- SPF .....	16	Toner cartridge life.....	47
Original table.....	5	Toner cartridge replacement .....	45
Original to copy indicator .....	6	Toner cartridge replacement	
Original to copy key .....	6, 12	indicator .....	6, 45, 51
<b>P</b>		Transfer charger .....	5, 49
Paper .....	7	Tray select key .....	6, 19
Paper feed location indicator .....	6	Troubleshooting.....	50
Paper output tray .....	5	Troubleshooting the unit.....	50
Paper output tray extension .....	5	<b>U</b>	
Paper tray .....	5, 8	USB interface cable .....	26
Photo copying .....	17	Using the manual.....	4
Photoconductive drum .....	5, 54, 55	Using the printer mode .....	30
Power cord socket .....	5	Using the scanner mode.....	32
Power off.....	14	Using the SHARP TWAIN .....	38
Power on.....	13	<b>Z</b>	
Power save indicator.....	6, 29	ZOOM indicator .....	6, 19
Power save mode indicator.....	43	ZOOM key .....	6, 19
Power switch.....	5, 13		
Preheat mode .....	43		
Printer driver .....	20		
Proper storage .....	2		
<b>R</b>			
Reduction/enlargement/zoom .....	19		
<b>S</b>			
Scan head locking switch.....	57		
Scanner driver.....	20		
Scanner indicator .....	6, 29		

---

---

## INDEX BY PURPOSE

---

---

Cleaning the unit		Removing paper jams	
- Cabinet .....	48	- Fusing area .....	53
- Original cover .....	48	- Lower paper feed area .....	55
- Original table .....	48	- Paper feed area .....	53
- SPF .....	48	- SPF .....	55
- Transfer changer .....	49	- Transport area .....	54
Connecting a USB interface cable .....	26	Replacing the toner cartridge .....	45
Copying .....	12	Scanning	
Displaying total number of copies .....	44	- Button Manager .....	37
Enlarging/reducing copies .....	19	- Scanner and Camera Wizard .....	40
Installing the software		- SHARP TWAIN .....	39
- Button Manager .....	20	Selecting the tray .....	19
- MFP driver .....	20	Setting the copy quality	
- Sharpdesk .....	20	- AUTO .....	17
Loading paper		- MANUAL .....	17
- Multi-bypass tray .....	10	- PHOTO .....	18
- Paper tray .....	7	Setting the copy quantity .....	17
Loading the original .....	15	Setting the toner save mode .....	42
- Original table .....	15	Setting the user program .....	43
- SPF .....	16	Setting up the Button Manager .....	32
Opening the printer driver .....	30	Storing the supplies .....	2
Power off .....	14	Using the online manual .....	41
Power on .....	13		
Printing .....	30		

### 1.PRODUCT AND COMPANY IDENTIFICATION

**Product Name** : AR-208NT/ AR-208T (Black Toner)

**Supplier Identification** : Sharp Corporation  
22-22 Nagaike-cho, Abeno-ku, Osaka, Japan

Local suppliers are listed below. Please contact the nearest supplier for additional information.

Area	(Country)	(Name and Telephone Number)
North America	U.S.A.	Sharp Electronics Corporation Sharp Plaza, Mahwah, NJ Telephone number for information : 1-800-237-4277 Emergency telephone number : 1-800-255-3924
	Canada	Sharp Electronics of Canada Ltd. Telephone number for information : 905-890-2100 Emergency telephone number : 1-800-255-3924
Oceania	Australia	Sharp Corporation of Australia PTY. Ltd. No1 Huntingwood Drive Huntingwood Blacktown N.S.W. Telephone number for information : 1300-13-50-22
Europe	Germany	Sharp Electronics (Europe) GMBH Sonninstrasse 3, 20097 Hamburg Telephone number to access MSDS : 040-2376-2185 For more information : 040-2376-2613
	United Kingdom	Sharp Electronics (U. K.) Ltd. Telephone number for information : 08705-274-277
	France	Sharp Electronics France S.A. Telephone number for information : 01-49-90-34-00
	Austria	Sharp Electronics GMBH Telephone number for information : 01-727-19-0
	Italy	Sharp Electronics (Italy) S.P.A. Telephone number for information : 02895951
	Spain	Sharp Electronics (Espana) S.A. Telephone number for information : 93-581-97-00
	Netherlands	Sharp Electronics Benelux B.V. Telephone number for information : 30-6359500
	Sweden	Sharp Electronics Nordic AB Telephone number for information : 08-634-36-00
	Switzerland	Sharp Electronics(Schweiz)AG Telephone number for information : 01-846-6111
Middle East	U.A.E.	Sharp Middle East FZE P.O.Box 17115 Jebel Ali, Dubai Telephone number for information : 04-815311

### 2.COMPOSITION / INFORMATION ON INGREDIENTS

Substance[ ] Ingredient	Preparation[X] CAS No.	Proportion	OSHA PEL	ACGIH TLV	MAK-TWA	NOHSC-TWA
Styrene-Acrylate copolymer	29497-14-1	85-95%	Not listed	Not listed	Not listed	Not listed
Carbon black	1333-86-4	5-10%	3.5mg/m <sup>3</sup>	3.5mg/m <sup>3</sup>	Not listed	3mg/m <sup>3</sup>
Iron oxide	1309-38-2	1-5%	Not listed	Not listed	Not listed	Not listed
Metal Complex dye*	109125-51-1 84179-66-8	< 2%	0.5mg/m <sup>3</sup>	0.5mg/m <sup>3</sup>	Not listed	Not listed

\* EC NO. : 400-110-2, Symbol letter : F,N , R Phrase : R11, R50/53

Date Issued : Nov. 1, 2007  
MSDS No. F-01601

---

### 3. HAZARDS IDENTIFICATION

---

**Most Important Hazards and Effects of the Products**

**Human Health Effects** : There are no anticipated carcinogenic effects from exposure based on animal tests performed using toner. When used as intended according to instructions, studies do not indicate any symptoms of fibrosis will occur.

**Environmental Effects** : Not toxic to aquatic organisms  
[Estimated from the other product containing similar material]

**Specific Hazards** : Dust explosion (like most finely divided organic powders)

**Directive 1999/45/EC(Europe)** : Not classified as dangerous

---

### 4. FIRST-AID MEASURES

---

<b>Route(s) of Entry :</b>	<b><u>Inhalation?</u></b>	<b><u>Skin?</u></b>	<b><u>Ingestion?</u></b>
	Yes	No	Possible but very unusual.

**Inhalation** : Remove to fresh air. If symptoms occur, consult medical personnel.

**Skin Contact** : Wash with soap and water for 15 minutes or until particle is removed.

If irritation does occur, consult medical personnel.

**Eye Contact** : Flush eyes immediately with water for 15 minutes. If irritation does occur, consult medical personnel.

**Ingestion** : Rinse with water and drink several glasses of water. If irritation or discomfort does occur, consult medical personnel.

---

### 5. FIRE-FIGHTING MEASURES

---

**Extinguishing Media** : Water, CO<sub>2</sub>, foam and dry chemicals

**Special Fire Fighting Procedures** : None

**Fire and Explosion Hazards** : Toner material, like most finely divided organic powders, may form an explosive mixture.

---

### 6. ACCIDENTAL RELEASE MEASURES

---

**Personal Precautions** : None

**Environmental Precautions** : None

**Methods for Cleaning Up** : Wipe off with paper or cloth. Do not use vacuum cleaner when a large amount is released. It, like most finely divided organic powders, is capable of creating a dust explosion.

---

### 7. HANDLING AND STORAGE

---

**Handling**

Technical Measures : None

Precautions : None

Safe Handling Advice : Use of a dust mask is recommended when handling a large quantity of toner or during long term exposure, as with any non-toxic dust. Try not to disperse the particles.

**Storage**

Technical Measures : None

Storage Conditions : Keep container closed and Store in a cool and dry place.  
Keep out of the reach of children.

Incompatible Products : None

---

### 8. EXPOSURE CONTROLS / PERSONAL PROTECTION

---

**Engineering Measures**

Ventilation : Not required under intended use.

---

Date Issued : Nov. 1, 2007  
MSDS No. F-01601**Exposure Limit Values**OSHA-PEL(USA) : 15mg/m<sup>3</sup> (Total Dust), 5mg/m<sup>3</sup> (Respirable Dust)  
ACGIH-TLV(USA) : 10mg/m<sup>3</sup> (Total Dust), 3mg/m<sup>3</sup> (Respirable Dust)**Personal Protective Equipment**Respiratory Protection : Not required under intended use.  
Hand Protection : Not required under intended use.  
Eye Protection : Not required under intended use.  
Skin Protection : Not required under intended use.  
Other Protective Equipment : Use of a dust mask and goggles are recommended when handling a large quantity of toner or during long term exposure, as with any non-toxic dust.**9. PHYSICAL AND CHEMICAL PROPERTIES****Appearance**

Physical State : Solid Form : Powder Color : Black Odor : odorless

Ph : Not applicable

**Boiling / Melting Point** : Not applicable**Softening Point(°C)** : 100 - 130**Flash Point(°C)** : Not applicable**Ignition Point(°C)** : > 350**Explosion Properties** : No data**Density(g/cm<sup>3</sup>)** : 1.1 (bulk density : 0.35)**Solubility in Water** : Negligible**10. STABILITY AND REACTIVITY****Stability** : Stable**Hazardous Reactions** : Dust explosion, like most finely divided organic powders.**Conditions to Avoid** : Electric discharge, throwing into fire.**Materials to Avoid** : Oxidizing Materials**Hazardous Decomposition Products** : CO, CO<sub>2</sub> and NO<sub>x</sub>**Further Information** : None**11. TOXICOLOGICAL INFORMATION****Acute Toxicity**Ingestion(oral) : LD<sub>50</sub> > 2500mg/kg [Estimated from the other product containing similar material]

Inhalation : No data

Eye irritation : Not an irritant [Estimated from the other product containing similar material]

Skin irritation : Not an irritant [Estimated from the other product containing similar material]

Skin sensitizer : No sensitized [Estimated from the other product containing similar material]

**Mutagenicity** : Negative (Ames Test) [Estimated from the other product containing similar material]**Carcinogenicity** : In 1996 the IARC reevaluated carbon black as a Group 2B carcinogen (possible human carcinogen). This classification is given to chemicals for which there is inadequate human evidence, but sufficient animal evidence on which to base an opinion of carcinogenicity. The classification is based upon the development of lung tumors in rats receiving chronic inhalation exposures to free carbon black at levels that induce particle overload of the lung. Studies performed in animal models other than rats did not show any association between carbon black and lung tumors. Moreover, a two-year cancer bioassay using a typical toner preparation containing carbon black demonstrated no association between toner exposure and tumor development in rats.



Date Issued : Nov. 1, 2007  
MSDS No. F-01601

**Chronic Effect** : In a study in rats of chronic inhalation exposure to a typical toner, a mild to moderate degree of lung fibrosis was observed in 92% of the rats in the high concentration (16mg/m<sup>3</sup>) exposure group, and a minimal to mild degree of fibrosis was noted in 22% of the animals in the middle (4mg/m<sup>3</sup>) exposure group, but no pulmonary change was reported in the lowest (1mg/m<sup>3</sup>) exposure group, the most relevant level to potential human exposures.

---

**12.ECOLOGICAL INFORMATION**

---

**Ecotoxicity** : On available data, toner is not harmful to aquatic organisms  
[Estimated from the other product containing similar material]

---

**13.DISPOSAL CONSIDERATIONS**

---

**Waste from Residues** : Waste material may be dumped or incinerated under conditions which meet all federal, state and local environmental regulations.

**Contaminated Packaging** : Waste may be disposed or incinerated under conditions which meet all federal, state and local environmental regulations.

---

**14.TRANSPORT INFORMATION**

---

UN Classification : None  
Not classified as hazardous for transport.

---

**15.REGULATORY INFORMATION**

---

## US Information

TSCA(Toxic Substances Control Act) :

All chemical substances in this product comply with all applicable rules or order under TSCA.

SARA(Superfund Amendments and Reauthorization Act) Title III

302 Extreme Hazardous Substance : None

311/312 Hazard Classification : None

## EU Information

1999/45/EC and 67/548/EEC

Symbol & Indication : Not required

R-Phrase : Not required

76/769/EEC : All chemical substances in this product comply with all applicable rules or order under 76/769/EEC.

---

**16.OTHER INFORMATION**

---

NFPA Rating (USA) : Health=1 Flammability=1 Reactivity=0

WHMIS Legislation (Canada) : This product is not a controlled product.

List of R phrases : R11 : Highly flammable

R50/53 : Very toxic to aquatic organisms, may cause long-term adverse effects in the aquatic environment.

## References

IARC(1996) : IARC monographs on the Evaluation of the Carcinogenic Risk of Chemicals to Humans, Vol. 65, Printing Process And Printing Inks, Carbon Black and Some Nitro Compounds, Lyon, pp.149-261

H.Muhle, B.Bellmann, O.Creutzenberg, C.Dasenbrock, H.Ernst, R.Kilpper, J.C.MacKenzie, P.Morrow, U.Mohr, S.Takenaka, and R.Mermelstein(1991) Pulmonary Response to Toner upon Chronic Inhalation Exposure in Rats. Fundamental and Applied Toxicology 17, pp.280-299.

The information on this data sheet represents our current data and best opinion as to the proper use in handling of this product under normal conditions. However, all materials may present unknown hazards and should be used with caution. Although certain hazards are described herein, we do not guarantee that these are the only hazards which exist.

---

Date Issued : Nov.01, 2007  
MSDS No. F-31601

### 1.PRODUCT AND COMPANY IDENTIFICATION

**Product Name** : AR-208ND / AR-208DV (Black Developer)

**Supplier Identification** : Sharp Corporation

22-22 Nagaike-cho, Abeno-ku, Osaka, Japan

Local suppliers are listed below. Please contact the nearest supplier for additional information.

Area	(Country)	(Name and Telephone Number)
North America	U.S.A.	Sharp Electronics Corporation Sharp Plaza, Mahwah, NJ Telephone number for information : 1-800-237-4277 Emergency telephone number : 1-800-255-3924
	Canada	Sharp Electronics of Canada Ltd. Telephone number for information : 905-890-2100 Emergency telephone number : 1-800-255-3924
Oceania	Australia	Sharp Corporation of Australia PTY. Ltd. No1 Huntingwood Drive Huntingwood Blacktown N.S.W. Telephone number for information : 1300-13-50-22
Europe	Germany	Sharp Electronics (Europe) GMBH Sonninstrasse 3, 20097 Hamburg Telephone number to access MSDS : 040-2376-2185 For more information : 040-2376-2613
	United Kingdom	Sharp Electronics (U. K.) Ltd. Telephone number for information : 08705-274-277
	France	Sharp Electronics France S.A. Telephone number for information : 01-49-90-34-00
	Austria	Sharp Electronics GMBH Telephone number for information : 01-727-19-0
	Italy	Sharp Electronics (Italy) S.P.A. Telephone number for information : 02895951
	Spain	Sharp Electronics (Espana) S.A. Telephone number for information : 93-581-97-00
	Netherlands	Sharp Electronics Benelux B.V. Telephone number for information : 30-6359500
	Sweden	Sharp Electronics Nordic AB Telephone number for information : 08-634-36-00
Middle East	U.A.E.	Sharp Middle East FZE P.O.Box 17115 Jebel Ali, Dubai
		Telephone number for information : 04-815311

### 2.COMPOSITION / INFORMATION ON INGREDIENTS

Substance[ ]

Preparation[X]

Ingredient	CAS No.	Proportion	OSHA PEL	ACGIH TLV	MAK-TWA	NOHSC-TWA
Iron powder	7439-89-6	85-95 %	Not listed	Not listed	Not listed	Not listed
Styrene-Acrylate copolymer	29497-14-1	5-10 %	Not listed	Not listed	Not listed	Not listed
Carbon black	1333-86-4	< 1 %	3.5mg/m <sup>3</sup>	3.5mg/m <sup>3</sup>	Not listed	3mg/m <sup>3</sup>

Date Issued : Nov.01, 2007  
MSDS No. F-31601

---

**3.HAZARDS IDENTIFICATION**

---

**Most Important Hazards and Effects of the Products**

Human Health Effects : There are no anticipated carcinogenic effects from exposure based on animal tests performed using toner. When used as intended according to instructions, studies do not indicate any symptoms of fibrosis will occur.

Environmental Effects : Not toxic to aquatic organisms  
[Estimated from the other product containing similar material]

**Specific Hazards** : Dust explosion (like most finely divided organic powders)

**Directive 1999/45/EC(Europe)** : Not classified as dangerous

---

**4.FIRST-AID MEASURES**

---

Route(s) of Entry :	<u>Inhalation?</u>	<u>Skin?</u>	<u>Ingestion?</u>
	No	No	Possible but very unusual.

**Inhalation** : Remove to fresh air. If symptoms occur, consult medical personnel.

**Skin Contact** : Wash with soap and water for 15 minutes or until particle is removed.  
If irritation does occur, consult medical personnel.

**Eye Contact** : Flush eyes immediately with water for 15 minutes. If irritation does occur, consult medical personnel.

**Ingestion** : Rinse with water and drink several glasses of water. If irritation or discomfort does occur, consult medical personnel.

---

**5.FIRE-FIGHTING MEASURES**

---

**Extinguishing Media** : Water, CO<sub>2</sub>, foam and dry chemicals

**Special Fire Fighting Procedures** : None

**Fire and Explosion Hazards** : Toner material, like most finely divided organic powders, may form an explosive mixture.

---

**6.ACCIDENTAL RELEASE MEASURES**

---

**Personal Precautions** : None

**Environmental Precautions** : None

**Methods for Cleaning Up** : Wipe off with paper or cloth. Do not use vacuum cleaner when a large amount is released. It, like most finely divided organic powders, is capable of creating a dust explosion.

---

**7.HANDLING AND STORAGE**

---

**Handling**

Technical Measures : None

Precautions : None

Safe Handling Advice : Use of a dust mask is recommended when handling a large quantity of toner or during long term exposure, as with any non-toxic dust. Try not to disperse the particles.

**Storage**

Technical Measures : None

Storage Conditions : Keep container closed and Store in a cool and dry place.  
Keep out of the reach of children.

Incompatible Products : None

---

**8.EXPOSURE CONTROLS / PERSONAL PROTECTION**

---

**Engineering Measures**

Ventilation : Not required under intended use.

---

Date Issued : Nov.01, 2007

MSDS No. F-31601

**Exposure Limit Values**OSHA-PEL(USA) : 15mg/m<sup>3</sup> (Total Dust), 5mg/m<sup>3</sup> (Respirable Dust)ACGIH-TLV(USA) : 10mg/m<sup>3</sup> (Total Dust), 3mg/m<sup>3</sup> (Respirable Dust)**Personal Protective Equipment**

Respiratory Protection : Not required under intended use.

Hand Protection : Not required under intended use.

Eye Protection : Not required under intended use.

Skin Protection : Not required under intended use.

Other Protective Equipment : Use of a dust mask and goggles are recommended when handling a large quantity of toner or during long term exposure, as with any non-toxic dust.

**9. PHYSICAL AND CHEMICAL PROPERTIES****Appearance**

Physical State : Solid Form : Powder Color : Black Odor : odorless

**Ph** : Not applicable**Boiling / Melting Point** : Not applicable**Flash Point(°C)** : Not applicable**Ignition Point(°C)** : No data**Explosion Properties** : No data**Density(g/cm<sup>3</sup>)** : 7.3 (bulk density : 2.0)**Solubility in Water** : Negligible**10. STABILITY AND REACTIVITY****Stability** : Stable**Hazardous Reactions** : Dust explosion, like most finely divided organic powders.**Conditions to Avoid** : Electric discharge, throwing into fire.**Materials to Avoid** : Oxidizing Materials**Hazardous Decomposition Products** : CO, CO<sub>2</sub> and NO<sub>x</sub>**Further Information** : None**11. TOXICOLOGICAL INFORMATION****Acute Toxicity**Ingestion(oral) : LD<sub>50</sub> > 2000mg/kg [Estimated from the other product containing similar material]

Inhalation : No data

Eye irritation : Not an irritant [Estimated from the other product containing similar material]

Skin irritation : Not an irritant [Estimated from the other product containing similar material]

Skin sensitizer : No sensitized [Estimated from the other product containing similar material]

**Mutagenicity** : Negative (Ames Test) [Estimated from the other product containing similar material]**Carcinogenicity** : In 1996 the IARC reevaluated carbon black as a Group 2B carcinogen (possible human carcinogen). This classification is given to chemicals for which there is inadequate human evidence, but sufficient animal evidence on which to base an opinion of carcinogenicity. The classification is based upon the development of lung tumors in rats receiving chronic inhalation exposures to free carbon black at levels that induce particle overload of the lung. Studies performed in animal models other than rats did not show any association between carbon black and lung tumors. Moreover, a two-year cancer bioassay using a typical toner preparation containing carbon black demonstrated no association between toner exposure and tumor development in rats.

Date Issued : Nov.01, 2007  
MSDS No. F-31601

**Chronic Effect** : In a study in rats of chronic inhalation exposure to a typical toner, a mild to moderate degree of lung fibrosis was observed in 92% of the rats in the high concentration (16mg/m<sup>3</sup>) exposure group, and a minimal to mild degree of fibrosis was noted in 22% of the animals in the middle (4mg/m<sup>3</sup>) exposure group, but no pulmonary change was reported in the lowest (1mg/m<sup>3</sup>) exposure group, the most relevant level to potential human exposures.

---

**12.ECOLOGICAL INFORMATION**

---

**Ecotoxicity** : On available data, toner is not harmful to aquatic organisms  
[Estimated from the other product containing similar material]

---

**13.DISPOSAL CONSIDERATIONS**

---

**Waste from Residues** : Waste material may be dumped or incinerated under conditions which meet all federal, state and local environmental regulations.

**Contaminated Packaging** : Waste may be disposed or incinerated under conditions which meet all federal, state and local environmental regulations.

---

**14.TRANSPORT INFORMATION**

---

UN Classification : None

Not classified as hazardous for transport.

---

**15.REGULATORY INFORMATION**

---

US Information

TSCA(Toxic Substances Control Act) :

All chemical substances in this product comply with all applicable rules or order under TSCA.

SARA(Superfund Amendments and Reauthorization Act) Title III

302 Extreme Hazardous Substance : None

311/312 Hazard Classification : None

EU Information

1999/45/EC and 67/548/EEC

Symbol & Indication : Not required

R-Phrase : Not required

76/769/EEC : All chemical substances in this product comply with all applicable rules or order under 76/769/EEC.

---

**16.OTHER INFORMATION**

---

NFPA Rating (USA) : Health=1 Flammability=1 Reactivity=0

WHMIS Legislation (Canada) : This product is not a controlled product.

References

IARC(1996) : IARC monographs on the Evaluation of the Carcinogenic Risk of Chemicals to Humans, Vol. 65, Printing Process And Printing Inks, Carbon Black and Some Nitro Compounds, Lyon, pp.149-261  
H.Muhle, B.Bellmann, O.Creutzenberg, C.Dasenbrock, H.Ernst, R.Kilpper, J.C.MacKenzie, P.Morrow, U.Mohr, S.Takenaka, and R.Mermelstein(1991) Pulmonary Response to Toner upon Chronic Inhalation Exposure in Rats. Fundamental and Applied Toxicology 17, pp.280-299.

The information on this data sheet represents our current data and best opinion as to the proper use in handling of this product under normal conditions. However, all materials may present unknown hazards and should be used with caution. Although certain hazards are described herein, we do not guarantee that these are the only hazards which exist.

---

## **A. Information on Disposal for Users (private households)**

### **1. In the European Union**

Attention: If you want to dispose of this equipment, please do not use the ordinary dust bin!

Used electrical and electronic equipment must be treated separately and in accordance with legislation that requires proper treatment, recovery and recycling of used electrical and electronic equipment.

Following the implementation by member states, private households within the EU states may return their used electrical and electronic equipment to designated collection facilities free of charge\*. In some countries\* your local retailer may also take back your old product free of charge if you purchase a similar new one.

\*) Please contact your local authority for further details.

If your used electrical or electronic equipment has batteries or accumulators, please dispose of these separately beforehand according to local requirements.

By disposing of this product correctly you will help ensure that the waste undergoes the necessary treatment, recovery and recycling and thus prevent potential negative effects on the environment and human health which could otherwise arise due to inappropriate waste handling.

### **2. In other Countries outside the EU**

If you wish to discard this product, please contact your local authorities and ask for the correct method of disposal.

For Switzerland: Used electrical or electronic equipment can be returned free of charge to the dealer, even if you don't purchase a new product. Further collection facilities are listed on the homepage of [www.swico.ch](http://www.swico.ch) or [www.sens.ch](http://www.sens.ch).



Attention: Your product is marked with this symbol. It means that used electrical and electronic products should not be mixed with general household waste. There is a separate collection system for these products.

## **B. Information on Disposal for Business Users.**

### **1. In the European Union**

If the product is used for business purposes and you want to discard it: Please contact your SHARP dealer who will inform you about the take-back of the product. You might be charged for the costs arising from take-back and recycling. Small products (and small amounts) might be taken back by your local collection facilities.

For Spain: Please contact the established collection system or your local authority for take-back of your used products.

### **2. In other Countries outside the EU**

If you wish to discard of this product, please contact your local authorities and ask for the correct method of disposal.

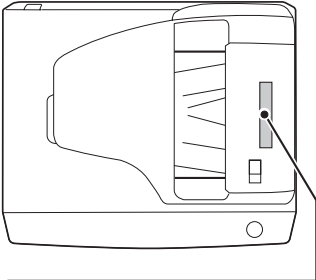

**CAUTION**

CLASS 3B INVISIBLE LASER RADIATION WHEN OPEN AND INTERLOCKS DEFEATED. AVOID EXPOSURE TO BEAM.

**VORSICHT**

UNSICTBARE LASERSTRAHLUNG DER KLASSE 3B, WENN ABDECKUNG GEÖFFNET UND SICHERHEITSVERRIEGELUNG ÜBERBRÜCKT. NICHT DEM STRAHL AUSSETZEN.

**ADVARSEL**

USYNLIG LASERSTRÅLING AF KLASSE 3B VED ÅBNING, NÅR SIKKERHEDSBRYDERE ER UDE AF FUNKTION. UNDGÅ UDSÆTTELSE FOR STRÅLING.

**ADVARSEL**

USYNLIG KLASSE 3B LASERSTRÅLING NÅR DEKSEL ÅPNES OG SIKKERHEDSLÅS BRYTES. UNNGÅ EKSPONERING FOR STRÅLEN.

**VARNING**

OSYNLIG LASERSTRÅLING KLASSE 3B NÅR DENNA DEL ÄR ÖPPNAD OCH SPÄRRAR ÄR URKOPPLADE. UNDVIK EXPONERING FÖR STRÅLEN.

**VARO!**

AVATTAESSA JA SUOJALUKITUS OHITETTAESSA OLET ALTIINA NÄKYMÄTÖNTÄ LUOKAN 3B LASERSÄTEILYLLE. ÄLÄ KATSO SÄTEESEEN.

	<p><b>CAUTION</b> CLASS 3B INVISIBLE LASER RADIATION WHEN OPEN AND INTERLOCKS DEFEATED. AVOID EXPOSURE TO BEAM.</p>	<p><b>ADVERSEL</b> USYNLIG KLASSE 3B LASERSTRÅLING NÅR DEKSEL ÅPNES OG SIKKERHEDSLÅS BRYTES. UNNGÅ EKSPONERING FOR STRÅLEN.</p>
	<p><b>VORSICHT</b> UNSICTBARE LASERSTRAHLUNG DER KLASSE 3B, WENN ABDECKUNG GEÖFFNET UND SICHERHEITSVERRIEGELUNG ÜBERBRÜCKT. NICHT DEM STRAHL AUSSETZEN.</p>	<p><b>VARNING</b> OSYNLIG LASERSTRÅLING KLASSE 3B NÅR DENNA DEL ÄR ÖPPNAD OCH SPÄRRAR ÄR URKOPPLADE. UNDVIK FÖR STRÅLEN.</p>
	<p><b>ADVARSEL</b> USYNLIG LASERSTRÅLING AF KLASSE 3B VED ÅBNING, NÅR SIKKERHEDSBRYDERE ER UDE AF FUNKTION. UNDGÅ UDSÆTTELSE FOR STRÅLING.</p>	<p><b>VARO!</b> AVATTAESSA JA SUOJALUKITUS OHITETTAESSA OLET ALTIINA NÄKYMÄTÖNTÄ LUOKAN 3B LASERSÄTEILYLLE. ÄLÄ KATSO SÄTEESEEN.</p>

CLASS 1 LASER PRODUCT

LASER KLASSE 1

LUOKAN 1 LASERLAITE

KLASS 1 LASERAPPARAT

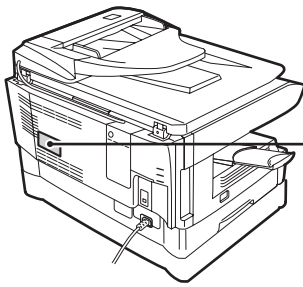

**CLASS 1  
LASER PRODUCT  
LASER KLASSE 1**

**SHARP Manufacturing France S.A.**  
Route de Bollwiller 68360 SOULTZ FRANCE



**SHARP®**